



OPTIVIEW

MANUFACTURER & DISTRIBUTOR

HDMI-WALL USER MANUAL



Table of Contents

1	OVERVIEW	1
1.1	General Introduction	1
1.2	Specifications	3
1.2.1	1-channel 4K High Definition Series	3
1.2.2	4-channel 4K High Definition Series	4
1.2.3	1/4-channel High Definition Series	5
1.2.4	9/16-channel High Definition Series.....	6
1.3	Features.....	8
2	FRONT PANEL/REAR PANEL/INSTALLATION.....	13
2.1	Check Unpacked HDMI-WALL.....	13
2.2	Front panel.....	13
2.2.1	1/4-channel 4K High Definition&1/4-channel High Definition Series	13
2.2.2	9/16-channel High Definition Series.....	14
2.3	Rear Panel.....	15
2.3.1	1-channel 4K high definition series	15
2.3.2	4-channel 4K high definition series	16
2.3.3	1-channel High Definition Series	16
2.3.4	4-channel High Definition Series	17
2.3.5	9-channel High Definition Series	17
2.3.6	16-channel High Definition Series	18
2.4	Connection.....	19
2.4.1	General Connection.....	19
2.4.2	Audio/Video Connection.....	19
2.4.3	Audio Talk Input Connection.....	19
2.4.4	Video Output Device and Connection.....	19
2.4.5	Audio Output	20

3	OPERATION.....	21
3.1	Boot Up and Shut Down	21
3.2	Login.....	21
3.2.1	Preparation.....	21
3.2.2	Login	22
3.3	Main Window	24
3.4	Video Wall Splicing (Display Pane) Function.....	30
3.5	Add /Remove Front-end Device.....	33
3.5.1	Add device.....	33
3.5.2	Delete Device.....	33
3.6	Decode Channel Setup.....	33
3.7	File Playback and Time Playback.....	34
3.7.1	File Playback.....	34
3.7.2	Time Playback	37
3.8	Decoder	37
3.8.1	Decode Tour	37
3.8.2	Decode Output.....	40
3.8.3	Decode Strategy	41
3.8.4	Screen Show.....	41
3.8.5	Output Options.....	42
3.8.6	Background Color	42
3.8.7	Split Line.....	43
3.9	Setting.....	43
3.9.1	General.....	43
3.9.2	Network	44
3.9.3	RS232.....	47
3.9.4	Alarm	53

3.9.5	Resolution	55
3.9.6	Account.....	55
3.10	Maintain	60
3.10.1	Version.....	60
3.10.2	Log	60
3.10.3	Sniffer.....	61
3.10.4	Default and Backup.....	64
3.10.5	Auto Maintenance	64
3.10.6	Connection mode	65
3.11	Log out.....	65
4	LOCAL GUI OPERATION.....	66
4.1	Boot up.....	66
4.2	About Interface.....	66
4.2.1	Main Interface	67
4.2.2	Device Tree.....	67
4.2.3	Shortcut Menu.....	69
4.3	GUI Basic Operation.....	70
4.3.1	Main Menu.....	70
4.3.2	Remote Device	78
4.3.3	Network	78
4.3.4	Close.....	78
5	ALARM INPUT AND OUTPUT	79
5.1	Alarm Input Port	81
5.2	Alarm Output Port	81
5.3	Alarm Output Relay Specifications	82

6	NETWORK KEYBOARD CONTROL DECODER EXPLANATION	84
6.1	Connection.....	84
6.1.1	Keyboard Setup after Serial Ports Connected	84
6.1.2	Keyboard Setup after Network Connected	85
6.2	Login method.....	85
6.3	Picture switch	85

Welcome

Thank you for purchasing our product!

This user's manual is designed to be a reference tool for the operation of your system.

Here you can find information about this series NVS's features and functions.

Before installation and operation please read the following safeguards and warnings carefully!

Important Safeguard and Warning

1 . Electrical safety

All installation and operation here should conform to your local electrical safety codes.

The product must be grounded to reduce the risk of electric shock.

We assume no liability or responsibility for all the fires or electrical shock caused by improper handling or installation.

Please use three-pin power socket (with GND).

We are not liable for any problems caused by unauthorized modifications or attempted repair.

2 . Installation

Do not apply power to the device before completing installation.

Do not put objects on the HDMI-WALL.

3 . Environment

The HDMI-WALL should be installed in a cool, dry place away from direct sunlight, inflammable, explosive substances and etc. Please guarantee sound ventilation and keep device clean.

4. About Accessories

Be sure to use all the accessories recommended by manufacturer.

Contact your local retailer ASAP if something is damaged in the accessory package.

1 Overview

1.1 General Introduction

These high definition series product is a network audio & video decode device designed and developed for the video network monitor system. It has elegant shape and strong data process capability. It has stable and sound network function and supports all popular encode modes. This series product has sound expansibility and it is easy to maintain and connect.

This kind of design is convenient for the whole network video surveillance system to install, control and manage. At the same time, it greatly reduces the system cost.

The decoder adopts embedded OS and effectively guarantees the security, stability, reliability and high performance of the network video surveillance system.

These series products all support window split function.

Model	Decode Output Capability	Output Port	Split Mode
1-channel 4K high definition series	<ul style="list-style-type: none">● 16-channel 1080P resolution video decode output● 12-channel 300w video decode output.● 7-channel 500w video decode output.● 6-channel 600w video decode output.● 4-channel 800w video decode output.● 1-channel 1200w video decode output.● 1-channel 1080P SVAC video decode output.● 1-channel 1080P H.265 video decode output.	<ul style="list-style-type: none">● VGA● HDMI	The TV screen supports 1/4/9/16-window display mode.
4-channel 4K high definition series	<ul style="list-style-type: none">● 4-channel 1200W video decode output.● 4-channel 800W video decode output.● 16-channel 1080P video decode output.	<ul style="list-style-type: none">● VGA● HDMI● BNC	The TV screen supports 1/4/9/16-window display mode.

Model	Decode Output Capability	Output Port	Split Mode
	<ul style="list-style-type: none"> • 36-channel 720P video decode output. • 64-channel 960H video decode output. • 4-channel 1200W H.265 video decode output. • 4-channel 800W H.265 video decode output. • 16-channel 1080P H.265 video decode output. • 36-channel 720P H.265 video decode output. • 64-channel 960H H.265 video decode output. 		
1-channel high definition series	<ul style="list-style-type: none"> • 4-channel 1080P resolution video decode output. • 12-channel 960H resolution video decode output • 16-channel D1 resolution video decode output 	<ul style="list-style-type: none"> • VGA • HDMI • BNC 	The TV screen supports 1/4/9/16-window display mode.
4-channel high definition series	<ul style="list-style-type: none"> • 7-channel 1080P resolution video decode output. • 24-channel 960H resolution video decode output • 28-channel D1 resolution video decode output 	<ul style="list-style-type: none"> • VGA • HDMI • BNC 	The first TV screen supports 1/4/9/16-window display mode. The rest TV screens support 1/4-window display mode.
9-channel high definition series	<ul style="list-style-type: none"> • 2-channel 800w resolution non-real time video decode output. • 8-channel 500w resolution non-real time video decode output. • 8-channel 300w resolution non-real time video decode output. • 9-channel 1080P resolution video decode output. 	<ul style="list-style-type: none"> • VGA • HDMI 	The first TV screen supports 1/4/9/16-window display mode. The rest TV screens support 1/4-window display mode.

Model	Decode Output Capability	Output Port	Split Mode
	<ul style="list-style-type: none"> • 33-channel 720P resolution video decode output. • 44-channel 960H resolution video decode output • 48-channel D1 resolution video decode output 		
16-channel high definition series	<ul style="list-style-type: none"> • 4-channel 800w resolution non-real time video decode output. • 16-channel 500w resolution non-real time video decode output. • 16-channel 300w resolution non-real time video decode output. • 26-channel 1080P 8 Mbps or 32-channel 1080P 6Mbps resolution video decode output. • 52-channel 720P resolution video decode output. • 64-channel 960H resolution video decode output • 64-channel D1 resolution video decode output 	<ul style="list-style-type: none"> • VGA • HDMI 	The TV screen supports 1/4-window display mode.

1.2 Specifications

1.2.1 1-channel 4K High Definition Series

System Parameter	Device Model	1-channel 4K high definition series
	Main Processor	High performance industry embedded micro processor
	OS	Embedded LINUX
	Input Device	Front panel button and keyboard
	Shortcut Menu	N/A
Hardware Port	Video Standard	SVAC/MPEG4/H.264/MJPEG/H.265
	Audio Standard	PCM/G711

Specification	Decode Display Resolution	QCIF/CIF/2CIF/HD1/D1/960H/720P/1080P/300w/500w/600w/800w/1200w
	Video Frame Rate	PAL:1~25f/s; NTSC:1~30f/s
	Bit stream Type	Composite stream/Video stream
	Video Output Channel	1 channel
	Video Output Port	VGA/HDMI
	Audio Output Channel	1 channel
	Audio Output Port	HDMI
	Communication Port	<ul style="list-style-type: none"> ● One RJ45 10M/ 100M/1000M self-adaptive Ethernet port ● One RS232 port ● One RS485 ports (semi-duplex)
	Audio Talk Channel	1 channel
	Audio Talk Port	RCA(Level: 2Vrms. Output resistance : 10kΩ)
	Alarm input	4 channels
	Alarm Output	4-ch relay output (30VDC 1A.125VAC 0/5A activation output)
Working Environment and Other Physical Specification	Power	DC12V, 3.3A
	Power Consumption	≤20W
	Working Temperature	-10℃~+55℃
	Working Humidity	10%—95% 86kpa—106kpa
	Dimension (mm)	440x300x42.1mm
	Weight	3.00 kg—3.50 kg

1.2.2 4-channel 4K High Definition Series

System Parameter	Device Model	4-channel 4K high definition series
	Main Processor	High performance industry embedded micro processor
	OS	Embedded LINUX
	Input Device	Front panel button and keyboard
	Shortcut Menu	N/A
Hardware Port	Video Standard	MPEG4/H.264/MJPEG/H.265
	Audio Standard	PCM/G711

Specification	Decode Display Resolution	QCIF/CIF/2CIF/HD1/D1/960H/720P/1080P/300w/500w/600w/800w/1200w
	Video Frame Rate	PAL:1~25f/s; NTSC:1~30f/s
	Bit stream Type	Composite stream/Video stream
	Audio/video input Channel	1 channel
	Audio/video input Port	HDMI
	Video Output Channel	4 channels
	Video Output Port	VGA/HDMI/BNC
	Audio Output Channel	4 channels
	Audio Output Port	HDMI/BNC(Level: 0.2V~3V, Output resistance: 5kΩ)
	Communication Port	<ul style="list-style-type: none"> ● One RJ45 10M/ 100M/1000M self-adaptive Ethernet port ● One RS232 port ● One RS485 port ● One RJ45 port for screen control
	Audio Talk Channel	1 channel
	Audio Talk Port	BNC(Level: 2Vrms. Output resistance : 10kΩ)
	Alarm input	4 channels
	Alarm Output	4-ch relay output (30VDC 1A.125VAC 0/5A activation output)
Working Environment and Other Physical Specification	Power	DC12V, 5.0A
	Power Consumption	≤40W
	Working Temperature	-10℃~+55℃
	Working Humidity	10%—95% 86kpa—106kpa
	Dimension (mm)	440×300×42.1mm
	Weight	3.00 kg—3.50 kg

1.2.3 1/4-channel High Definition Series

System Parameter	Device Model	1-channel high definition series	4-channel high definition series
	Main Processor	High performance industry embedded micro processor	

	OS	Embedded LINUX	
	Input Device	Front panel button and keyboard	
	Shortcut Menu	N/A	
Hardware Port Specification	Video Standard	MPEG4/H.264/ MJPEG	
	Audio Standard	PCM/G711	
	Decode Display Resolution	QCIF/CIF/2CIF/HD1/D1/960H/720P/1080P	
	Video Frame Rate	PAL:1~25f/s; NTSC:1~30f/s	
	Bit stream Type	Composite stream/Video stream	
	Video Output Channel	1 channels	4 channels
	Video Output Port	VGA/HDMI/BNC	
	Audio Output Channel	1 channel	4 channels
	Audio Output Port	HDMI/BNC (Level: 200-3000 mV. Resistance: 5Ω)	
	Communication Port	<ul style="list-style-type: none"> ● One RJ45 10M/ 100M/1000M self-adaptive Ethernet port ● One RS232 port ● Two duplex RS485 ports 	
	Audio Talk Channel	1 channel	
	Audio Talk Port	BNC(Level: 2Vrms. Output resistance : 10kΩ)	
	Alarm input	16 channels	
	Alarm Output	8-ch relay output (30VDC 1A.125VAC 0/5A activation output)	
Working Environment and Other Physical Specification	Power	DC12V, 3.3A	DC12V, 5.0A
	Power Consumption	≤10W	≤40W
	Working Temperature	-10℃~+55℃	
	Working Humidity	10%—95% 86kpa—106kpa	
	Dimension (mm)	440×300×42.1mm	
	Weight	3.00 kg—3.50 kg	

1.2.4 9/16-channel High Definition Series

System Parameter	Device Model	9-channel high definition series	16-channel high definition series
------------------	--------------	----------------------------------	-----------------------------------

	Main Processor	High performance industry embedded micro processor	
	OS	Embedded LINUX	
	Input Device	Front panel button and keyboard	
	Shortcut Menu	N/A	
Hardware Port Specification	Video Standard	MPEG4/H.264/ MJPEG	
	Audio Standard	PCM/G711	
	Decode Display Resolution	QCIF/CIF/2CIF/HD1/D1/960H/720P/1080P/300w/500w/600w/800w	
	Video Frame Rate	PAL:1~25f/s; NTSC:1~30f/s	
	Bit stream Type	Composite stream/Video stream	
	Video Output Channel	9 channels	16 channels
	Video Output Port	VGA/HDMI	VGA/HDMI
	Audio Output Channel	9 channels	16 channels
	Audio Output Port	HDMI/DB15 audio BNC	HDMI/DVI-I audio BNC
	Communication Port	<ul style="list-style-type: none"> ● One RJ45 10M/ 100M/1000M self-adaptive Ethernet port ● One RS232 port ● One standard RS485 port 	<ul style="list-style-type: none"> ● Two RJ45 10M/ 100M/1000M self-adaptive Ethernet ports ● One RS232 port ● One standard RS485 port
	Audio Talk Channel	1 channel	
	Audio Talk Port	3.5mm jack port, input port: 3.5mm port(Level 2V Line in/50mV Mic in, input resistance10k Ω); output port: 3.5mm port(Level 2V, output resistance 16 Ω)	
	Alarm input	4 channels	N/A
	Alarm Output	4-ch relay output (30VDC 1A.125VAC 0.5A activation output)	N/A
Working Environment and Other Physical Specification	Power	AC100-240V, 50Hz~60Hz	
	Power Consumption	$\leq 70W$	$\leq 90W$
	Working Temperature	-10 $^{\circ}C$ ~+55 $^{\circ}C$	

	Working Humidity	10%—95% 86kpa—106kpa	
	Dimension (mm)	440X408X70mm	448×440×89mm
	Weight	4.5kg~4.8kg	7kg~7.5kg

1.3 Features

Network	Property Setup	Network parameter setup such as IP, gateway, subnet mask. Support remote control.
	NTP	Synchronize system time via NTP service.
	DHCP	Automatically get network parameter such as IP parameter.
	Auto get	After you configured the front-end encode device information, decoder can automatically connect to the encode device and then begin work independently and reliably,
	Passive receive	In transmit mode, decoder can get the random data bit stream from the network server to realize decoding output.
Output	Window Split	<ul style="list-style-type: none"> ● 1-channel 4K high definition series: It supports 1/4/9/16-window split. ● 4-channel 4K high definition series: It supports 1/4/9/16-window split. ● 1-channel high definition series: It supports 1/4/9/16-window split. ● 4-channel high definition series: The first TV screen supports 1/4/9/16-window split; the 2-4 TV screens support 1/4/-window split. ● 9-channel high definition series: The first TV screen supports 1/4/9/16-window split; the 2-9 TV screens support 1/4/-window split. ● 16-channel high definition series: All TV screens support 1/4-window split.

	Display Tour	<ul style="list-style-type: none"> ● 1-channel 4K high definition series has one output interface set. It includes one VGA and one HDMI. ● 4-channel 4K high definition series has four output interface sets. One set includes one VGA, one HDMI and one BNC. ● 1-channel high definition series has one output interface set. It includes one VGA, one HDMI and one BNC. ● 4-channel high definition series has four output interface sets. One set includes one VGA, one HDMI and one BNC. ● 9-channel high definition series has nine HDMI ports and nine VGA ports. ● 16-channel high definition series has sixteen HDMI ports and sixteen VGA ports. <p>These four series products can realize real-time surveillance via monitor and support alarm tour output and decode tour.</p>
Input	Input Port	4-channel 4K high definition series has one HDMI input port.
Alarm	External Alarm	Multiple-channel relay alarm output to activate the peripheral alarm device (such as on-site light control), manual control and activation video output. Note The 16-channel high definition series has no external alarm output port and does not support external alarm output port.
	Decoder Alarm	Prompt current decode status in time.
	Precaution Measure	Alarm input port and alarm output port both have protection electricity to guarantee main device safety.
COM	Common COM	Device debug console.
	Network Keyboard	The key board can control the device via network port.
	Control Keyboard	The key board can control the device via RS232 port.
	Transparent COM	Transparent COM function.
	Screen Control COM	4-channel 4K high definition series has one screen control COM to control the video wall on/off, brightness, contrast, saturation, definition setup, BLC mode switch and etc.
Decode	Decode Capability (System auto recognize current decode load and can	<ul style="list-style-type: none"> ● 1-channel 4K high definition series: max supports 16-channel D1@25fps/30fps, 16-channel 1080P@25fps/30fps, 12-channel 300W@25fps/30fps , 7-channel 500W@25fps/30fps , 6-channel 600W@25fps/30fps , 4-channel 800W@25fps/30fps realtime output, and 1-channel 1200W@25fps/30fps

	<p>prompt abnormal situation in time.)</p>	<p>realtime output. Support 1-channel 1080P SVAC bit stream realtime output, 1-channel 1080P H.265 bit stream realtime output.</p> <ul style="list-style-type: none"> ● 4-channel 4K high definition series: max supports 4-channel 1200W@15fps video decode output, 4-channel 800W@30fps video decode output (One for each TV screen) , 16-channel 1080P video decode output (4 for each TV screen) , 36-channel 720P video decode output (9 for each TV screen) 64-channel 960H video decode output. 4-channel 1200W@15fps H.265 video decode output, 4-channel 800W@30fps H.265 video decode output (for each TV screen) , 16-channel 1080P H.265 video decode output(4 for each TV screen) , 36-channel 720P H.265 bit stream video decode output (9 for each TV screen) , 64-channel 960H H.265 bit stream video decode output. ● 1-channel high definition series max supports 16-channel D1 decode output (2M bit stream), 12-channel 960H decode output (2.5M bit stream), 8-channel 720P decode output (4M bit stream), 4-channel 1080P@25fps (8M bit stream) decode output. ● 4-channel high definition series max supports 28-channel D1 decode output (2M bit stream), 14-channel 720P decode output (4M bit stream. There are 8-channel on the first TV screen and each 2-channel for the rest TV screens), 24-channel 960H decode output (2M bit stream. The first TV supports 12-channel 960H and the rest TV support 4-channel 960H respectively), and 7-channel 1080P@25fps decode output (8M bit stream. There are 4-channel on the first TV screen and each 1-channel for the rest TV screens) ● 9-channel high definition series max supports 2-channel 800W @13fps non-realtime decode output(Any one from the TV1-TV2, any one from the TV5-TV6), 6-channel 600W @10fps non-realtime decode output,8-channel 500W @8fps non-realtime decode output, 8-channel 300w@15fps non-realtime decode output, 4-channel 300w@25fps realtime decode output (Any two from the TV1-TV4, any two from the TV5-TV8.), 9-channel 1080P decode output, 33-channel 720P decode output (There are 4-channel on the 1-8 TV screen respectively. The 9 TV screen supports 1-channel.), 44-channel 960H decode output (The first TV supports 12-channel and the rest TVs support 12-channel respectively), 48-channel D1 decode output.
--	--	---

		<ul style="list-style-type: none"> 16-channel high definition series max supports 4-channel 800W @13fps non-realtime decode output(Any one from the TV1-TV2, any one from the TV5-TV6,.any one from the TV9-TV10, any one from the TV13-TV14,), 12-channel 600W@10fps non-realtime decode output, 16-channel 500W@8fps non-realtime decode output, 16-channel 300w @15fps non-realtime decode output, 8-channel 300w @25fps realtime decode output (Any two from the TV1-TV4, any two from the TV5-TV8,. any two from the TV9-TV12, any two from the TV13-TV16,),32-channel 1080P decode output (Any eight from the TV1-TV4, any eight from the TV5-TV8,. any eight from the TV9-TV12, any eight from the TV13-TV16,), 52-channel 720P 4Mbps or 64-channel 720P 3Mbps decode output, 64-channel 960H decode output, 64-channel D1 decode output.
	Real-time stream decode	Get the local real-time bit stream of the encoder and then output.
	Previous stream decode	Get the local previous bit stream of the encoder and then output.
	Message feedback	All application ends can accurately get current decoding status.
User Management	Account Management	Add, modify, and delete user or user group. Modify user password.
	Right Management	Set different rights for different users.
	Security Management	Password protection. Three times login failure may result in account lock.
Others	Version Information	Display device important hardware port information, software version information and etc.
	Log Search	Record device important log. Support search by type.
	Time Synchronization	Set system time manually or synchronization PC time.
	Language Option	English
	DST	Set proper DST time according to different regions' setup.
	Auto maintenance	Auto maintain device regularly.
	DNS	Domain service
	Upgrade	Support various upgrade types such as U disk, network, and TFTP.
	Intelligent Operation	Support copy function for the same setup.

	Development	Provide decode device SDK. Provide demonstration software and development introduction.
--	-------------	--

2 Front Panel/Rear Panel/Installation

Note:

- All the installation and operations here should conform to your local electric safety rules.
- VGA cable quality and length can affect the video quality. It may result in distorted video, noise, black margin. The video quality may vary even if you are viewing the same video via different VGA cables.

2.1 Check Unpacked HDMI-WALL

When you received the HDMI-WALL from the shipping agency, please check whether there is any visible damage. The protective materials used for the package of the HDMI-HD can protect most accidental clashes during transportation. Then you can open the box to check the accessories. Please check the items in accordance with the list. Finally you can remove the protective film of the HDMI-WALL. The label at the bottom of the box is

very important. Usually we need you to present the serial number when we provide the service after sales.

2.2 Front panel





2.2.1 1/4-channel 4K High Definition&1/4-channel High Definition Series





The 1/4-channel 4K high definition and 1/4-channel high definition series front panel is shown as in Figure 2-1.



Figure 2-1

Please refer to the following sheet for detailed information.

Name	Icon	Function
Power button		Press it for three seconds to boot up or shut down the device. Press it three times within one second, it can clear device configuration.
Power indicator light		The indicator light becomes on when system boots up.
Network indicator light		The indicator light becomes on when abnormal network event occurs (offline, IP conflict and etc.)
USB port		Connect to external USB device.

Name	Icon	Function
Alarm indicator light		N/A
HDD indicator light		N/A
IR receiver		N/A
Output indicator light		It is to display output port working mode. For 1-channel 4K high definition series and 1-channel high definition series, only the first indicator light is effective. For 4-channel 4K high definition series and 4-channel high definition series, only the channel 1 to channel 4 indicator lights is effective.

2.2.2 9/16-channel High Definition Series

The 9-channel high definition series front panel is shown as in Figure 2-2.



Figure 2-2







The 16-channel high definition series front panel is shown as in Figure 2-3.



Figure 2-3

Please refer to the following sheet for detailed information.

Name	Icon	Function
Power button		Press it for three seconds to boot up or shut down the device. Press it three times within one second, it can clear device configuration.

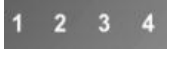
Name	Icon	Function
Power indicator light		The indicator light becomes on when system boots up.
Network indicator light		The indicator light becomes on when abnormal network event occurs (offline, IP conflict and etc.)
USB port		Connect to external USB device.
Alarm indicator light		N/A
HDD indicator light		N/A
IR receiver		N/A
Output indicator light		It is to display output port working mode. For 9-channel high definition series, only the channel 1 to channel 9 indicator light is effective. For 16-channel high definition series, only the channel 1 to channel 16 indicator light is effective.

2.3 Rear Panel

2.3.1 1-channel 4K high definition series

The rear panel is shown as below. See Figure 2-4.

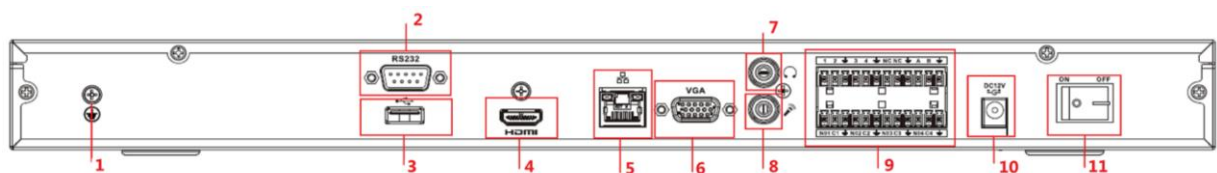

Figure 2-4

Please refer to the following sheet for detailed information.

SN	Port Name	SN	Port Name	SN	Port Name
1	Ground screw hole	2	RS232 port	3	USB port
4	HDMI port	5	Network interface(10M/100M/1000M self-adaptive Ethernet port)	6	VGA port

SN	Port Name	SN	Port Name	SN	Port Name
7	Audio talk output port RCA OUT	8	Audio talk input port RCA IN	9	4-channel alarm input, 4-channel alarm output, RS485 port.
10	Power socket	11	Power switch		

2.3.2 4-channel 4K high definition series

The rear panel is shown as below. See Figure 2-5.

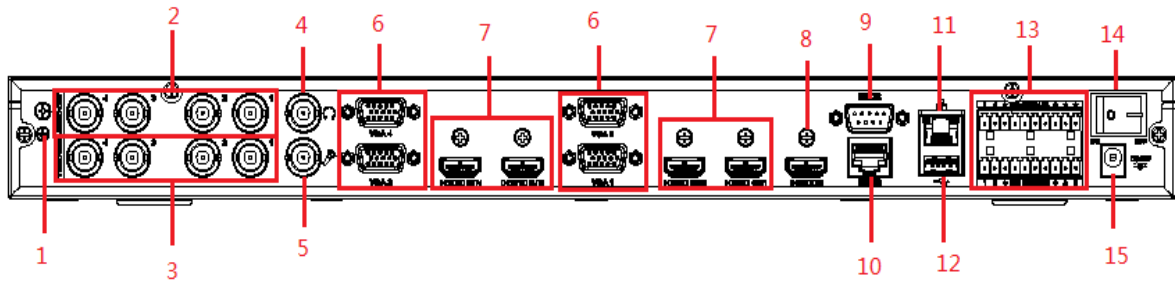

Figure 2-5

Please refer to the following sheet for detailed information.

SN	Port Name	SN	Port Name	SN	Port Name
1	Ground screw hole	2	Audio output port(BNC)	3	Video output port (BNC)
4	Audio talk input port	5	Audio talk output port	6	VGA port
7	HDMI output port	8	HDMI input port	9	RS232 port
10	RS232 port to control the screen	11	Network interface(10M/100M/1000 M self-adaptive Ethernet port)	12	USB port
13	Alarm input, alarm output, standard RS485 port	14	Power on-off button	15	Power socket

2.3.3 1-channel High Definition Series

The rear panel is shown as below. See Figure 2-6.

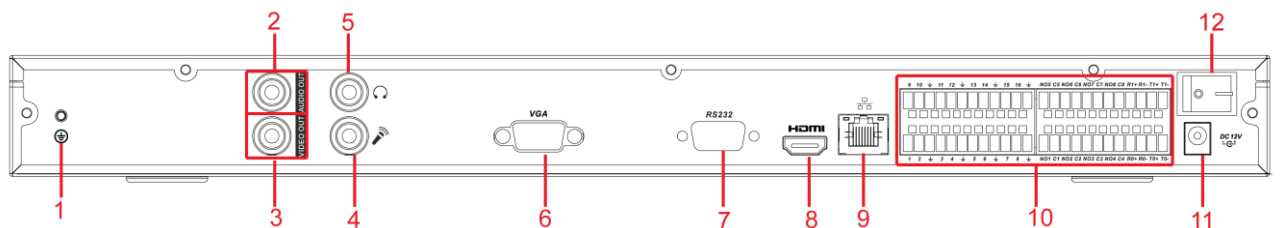

Figure 2-6

Please refer to the following sheet for detailed information.

SN	Port Name	SN	Port Name	SN	Port Name
1	Ground screw hole	2	Audio output port(BNC)	3	Video output port (BNC)
4	Audio talk input port	5	Audio talk output port	6	VGA port
7	RS232 port	8	HDMI port	9	Network interface(10M/100M/1000M self-adaptive Ethernet port)
10	Relay input, relay output, duplex RS485 port	11	Power socket	12	Power switch

2.3.4 4-channel High Definition Series

The rear panel is shown as in Figure 2-7.

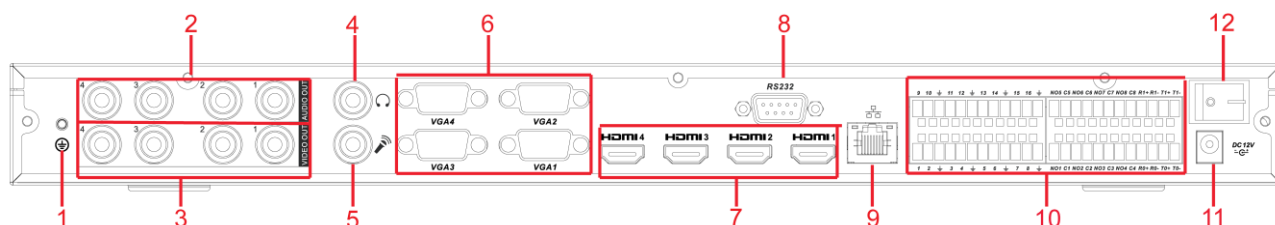

Figure 2-7

Please refer to the following sheet for detailed information.

SN	Port Name	SN	Port Name	SN	Port Name
1	Ground screw hole	2	Audio output port(BNC)	3	Video output port (BNC)
4	Audio talk output port	5	Audio talk input port	6	VGA port
7	HDMI port	8	RS232 port	9	Network interface(10M/100M/1000M self-adaptive Ethernet port)
10	Relay input, relay output, duplex RS485 port	11	Power socket	12	Power switch

2.3.5 9-channel High Definition Series

The rear panel is shown as below. See Figure 2-8.

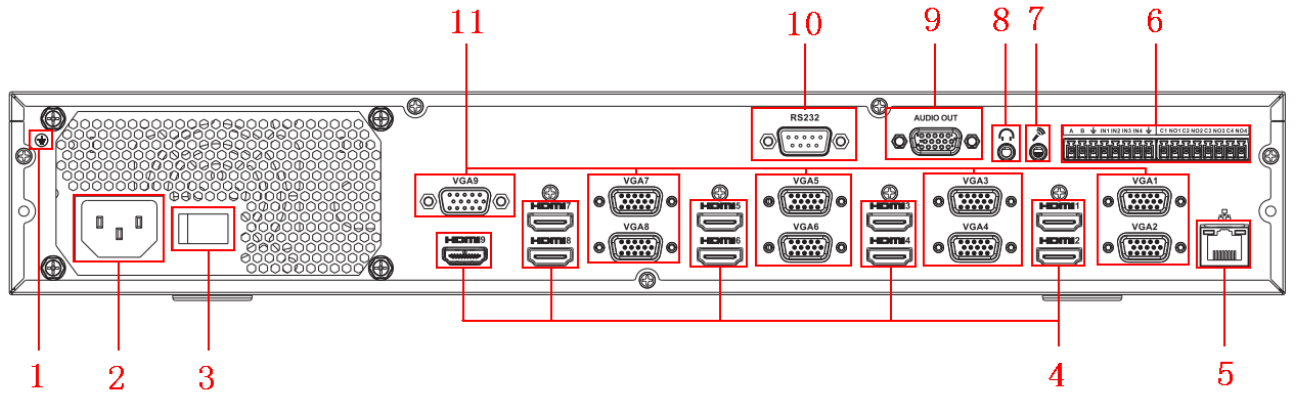

Figure 2-8

Please refer to the following sheet for detailed information.

SN	Port Name	SN	Port Name	SN	Port Name
1	Ground screw hole	2	Power switch	3	Power socket
4	HDMI port	5	Network interface(10M/100M/1000M self-adaptive Ethernet port)	6	Relay input, relay output, standard RS485 port.
7	Audio talk input port	8	Audio talk output port	9	Audio output port
10	RS232 port	11	VGA port		

2.3.6 16-channel High Definition Series

The rear panel is shown as below. See Figure 2-9.

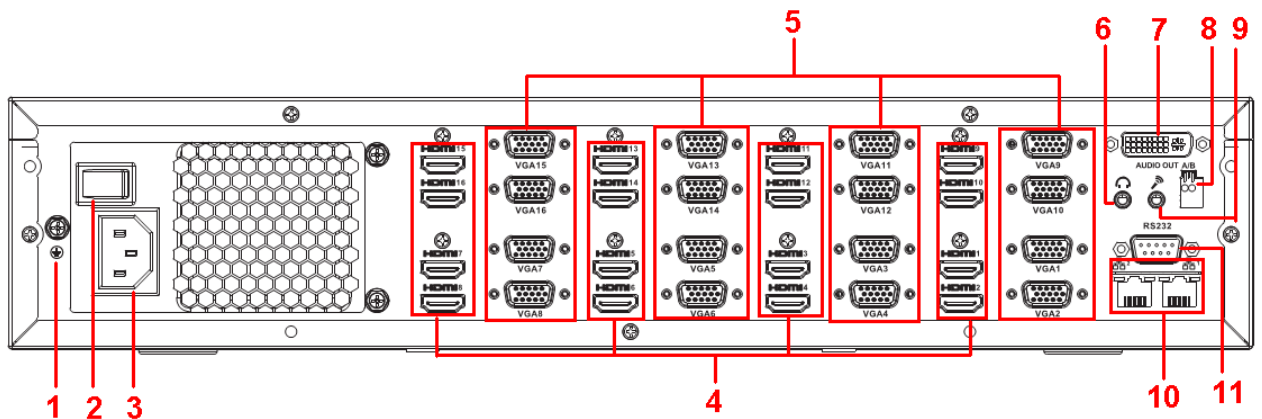

Figure 2-9

Please refer to the following sheet for detailed information.

SN	Port Name	SN	Port Name	SN	Port Name
1	Ground screw hole	2	Power switch	3	Power socket
4	HDMI port (16)	5	VGA port (16)	6	Audio talk output port
7	Audio output port	8	Standard RS485 port	9	Audio talk input port
10	Network	11	RS232 port		

	interface(10M/100M/1000M self-adaptive Ethernet port)			
--	---	--	--	--

Note:

When you connect it to the PC network port, please use crossover cable.
 When you connect it to the PC via router or switch, please use straight cable.

2.4 Connection

2.4.1 General Connection

Please refer to the follow figure for connection information. See Figure 2-10.
 The following figure is based on the 4-channel high definition series product.

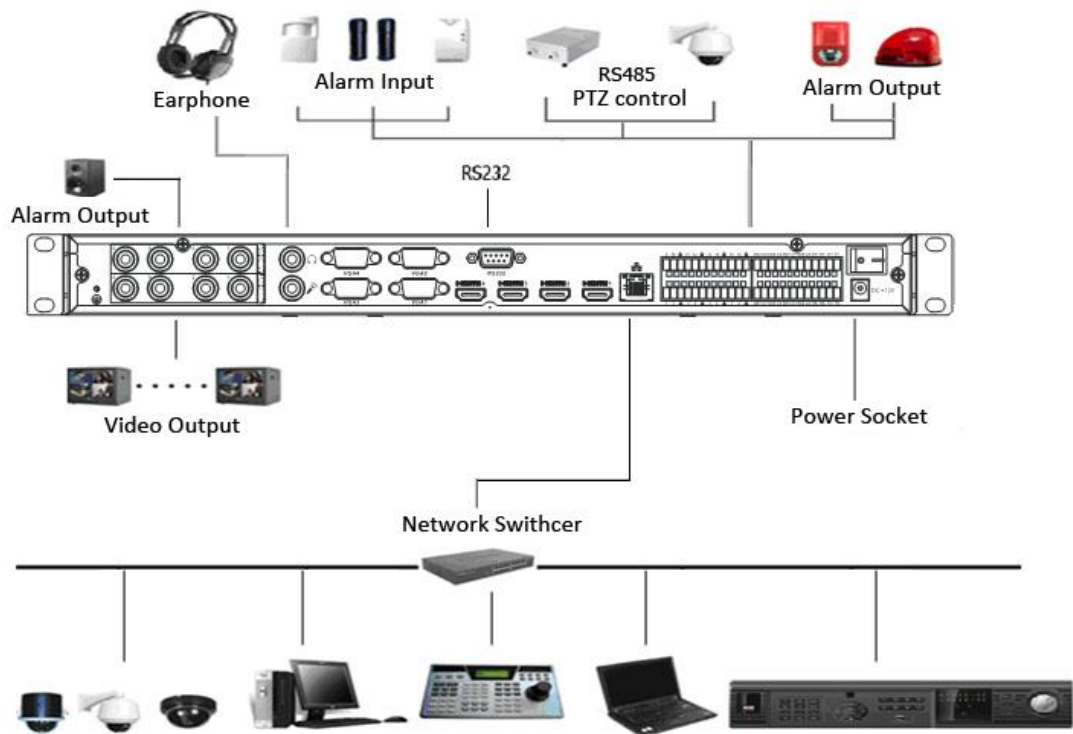

Figure 2-10

2.4.2 Audio/Video Connection

All audio and video data are encoding from the front-end device and then input to the network via RJ45 port.

2.4.3 Audio Talk Input Connection

It adopts BNC port.

2.4.4 Video Output Device and Connection

- 1-channel 4K high definition series adopts one output set. Each set has one VGA port, one HDMI port.
- 4-channel 4K high definition series adopts four output sets. Each set has one VGA port, one HDMI port and one BNC; BNC(1.0VP-P , 75Ω).
- 1-channel high definition series adopts one output set. Each set has one VGA port, one HDMI port and one BNC; BNC(1.0VP-P , 75Ω).
- 4-channel high definition series adopts four output sets. Each set has one VGA port, one HDMI port and one BNC; BNC(1.0VP-P , 75Ω).
- 9-channel high definition series adopts nine output sets. Each set has one VGA port, one HDMI port.
- 16-channel high definition series adopts sixteen output sets. Each set has one VGA port, one HDMI port.

Here we recommend the industry monitor to be the output device of the decoder. It has the following advantages:

- The industry monitor is suitable for long time surveillance. The pc monitor cannot run for such a long time. It is easy to be aging, damage or burn down.
- Industry monitor has stronger vivid and colorful video.
- Industry monitor can be used in many complicated environments and has strong anti-interference capability. It is more stable.

Please note, using TV as video output device is not a reliable substitution method. You need to reduce the working hours and control the interference from power supply and other devices. The risk of short circuit problem resulting from low quality TV may cause damage to other devices.

2.4.5 Audio Output

The audio output parameter of HDMI-WALL is 200mV 1kΩ (BNC), it can connect directly to low impedance earphone, active sound box or amplifier-drive audio output device. If the sound box and the pick-up cannot be separated spatially, it is easy to arouse squeaking. In this case you can adopt the following measures:

- Use pick-up with better directing property.
- Reduce the volume of the sound box until there is no squeaking.
- Using more sound-absorbing materials in decoration to reduce voice echo and improve acoustics environment.
- Adjust the layout to reduce risk of the squeaking.

3 Operation

- The following operations are generally based on the 9-channel high definition series product.
- Slight different may be found in the user interface.

3.1 Boot Up and Shut Down

Boot up

Connect the HDMI-WALL to the power and then press the power button in the rear panel. You can see the power indicator light becomes on and HDMI-WALL boots up. The system is in multiple-window display mode by default.

Shut down

You can press power button in the front panel for three seconds to shut down the device.

System Restore after Power Failure

When decoder is working, if the power failure occurs, the system can automatically connect to the front-end device and restore previous working status once the power connection becomes normal.

3.2 Login

3.2.1 Preparation

Before log in, please make sure:

- HDMI-WALL connection is OK.
- You have set PC IP address, HDMI-WALL IP address, subnet mask and gateway. (Please set the IP address of the same section for the PC and HDMI-WALL. Please input corresponding gateway and subnet mask if there are routers.) When HDMI-HD booted up normally, please input account name **admin** and password **admin** via the PC COM port., then input `net -a` and then input IP, NETMASK, GATEWAY. The command mode is: `net -a [IP] [NETMASDK] [GATEWAY]`.

For example:

Username: admin

Password: admin

DeBug>net -a 192.168.XXX.XXX 255.255.XXX.XXX 192.168.XXX.XXX

- Use order ping `***.***.***.***` (HDMI-WALL IP address) to check connection is OK or not. Usually the return TTL value should be less than 255.
- Open IE and then input the address in the column.
- WEB control can be downloaded and installed automatically. System can download the latest Web control and remove the old one.
- You can run `uninstall web.bat` to remove the control

- System is compatible with web control of WINVISTA. But you need to disable account control item and then reboot the PC.

3.2.2 Login

Open the IE and then input the HDMI-WALL IP address in the address column. For example, if your HDMI-WALL IP address is 192.168.1.100, then please input http:// 192.168.1.100 in IE address column. See Figure 3-1.

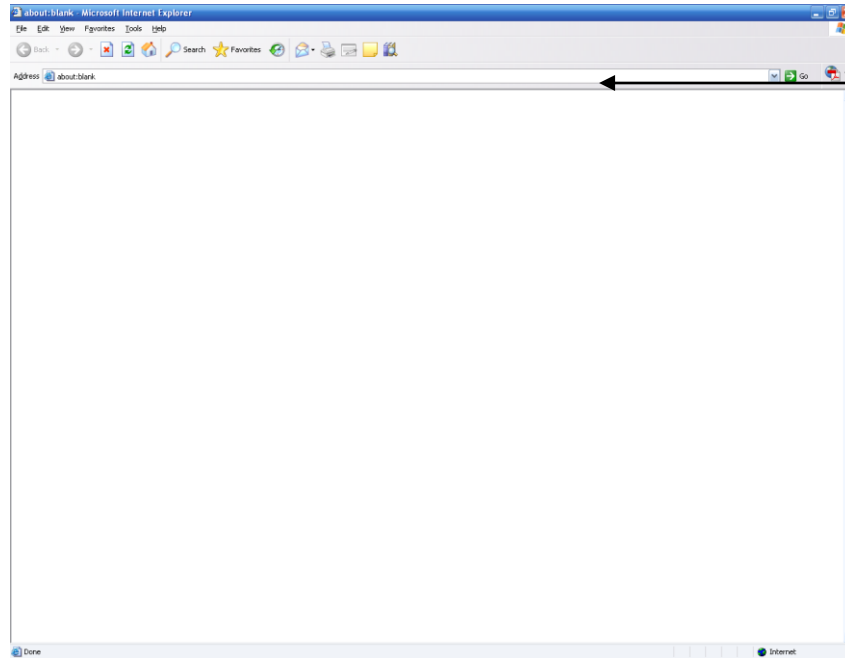

Input IP address here.

Figure 3-1

System pops up warning information to ask you whether install webrec.cab control or not. Please click yes button.

If you can't download the ActiveX file, please modify your settings as follows. See Figure 3-2.

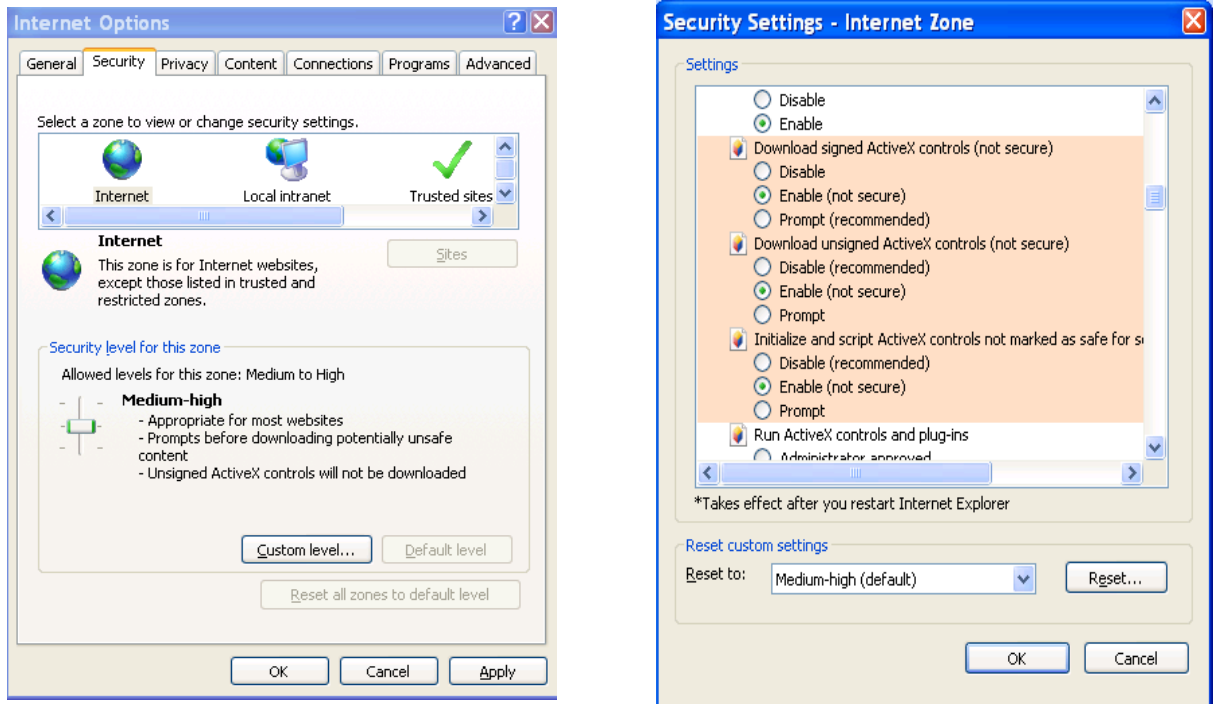

Figure 3-2

After installation, the interface is shown as below. See Figure 3-3.

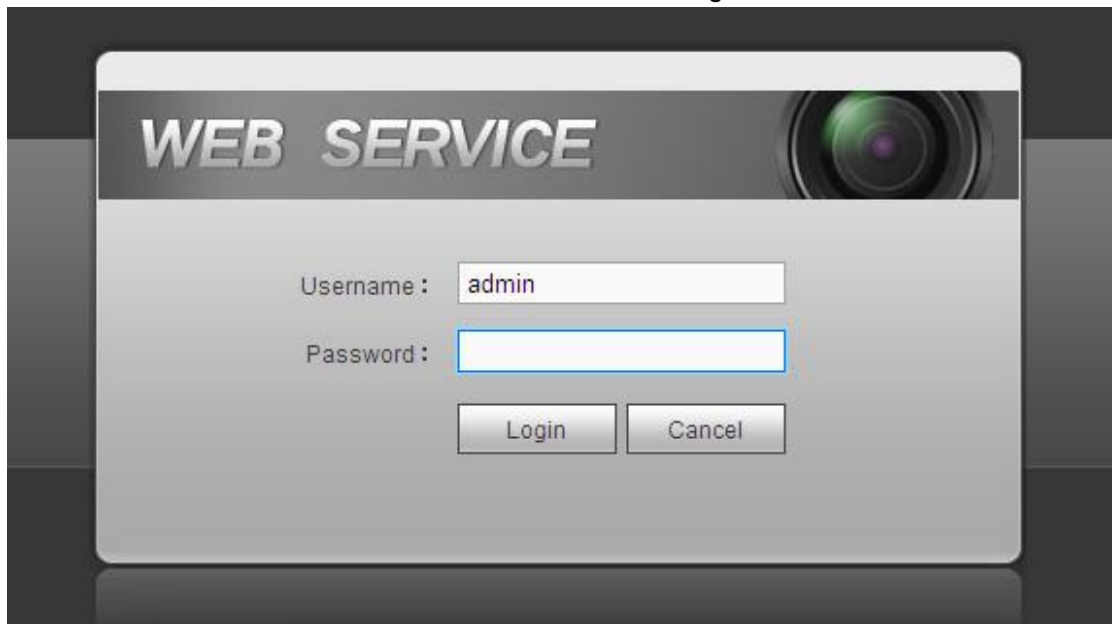

Figure 3-3

Please input your user name and password and then click Login button.

- Default factory name is **admin** and password is **admin**.
- **Note: For security reasons, please modify your password after you first login.**

Now you can see system pops up the following dialogue box to remind you to change the default password. See Figure 3-4.

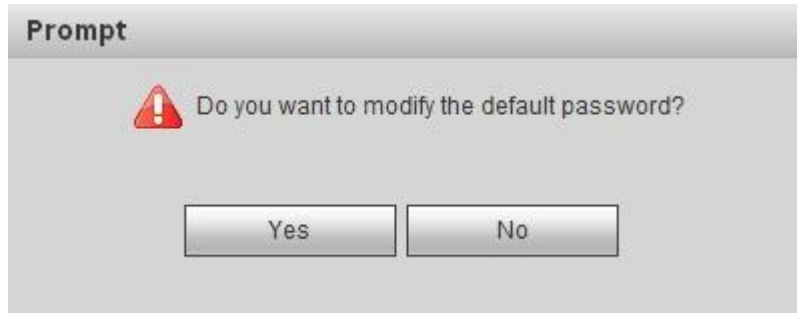

Figure 3-4

Click Yes button, you can see the Modify Password dialogue box. Please input the new password twice and then click the Yes button. See Figure 3-10. Click No button to remain the default password.



Figure 3-5

3.3 Main Window

After login successfully, the interface will be shown as Figure 3-6.

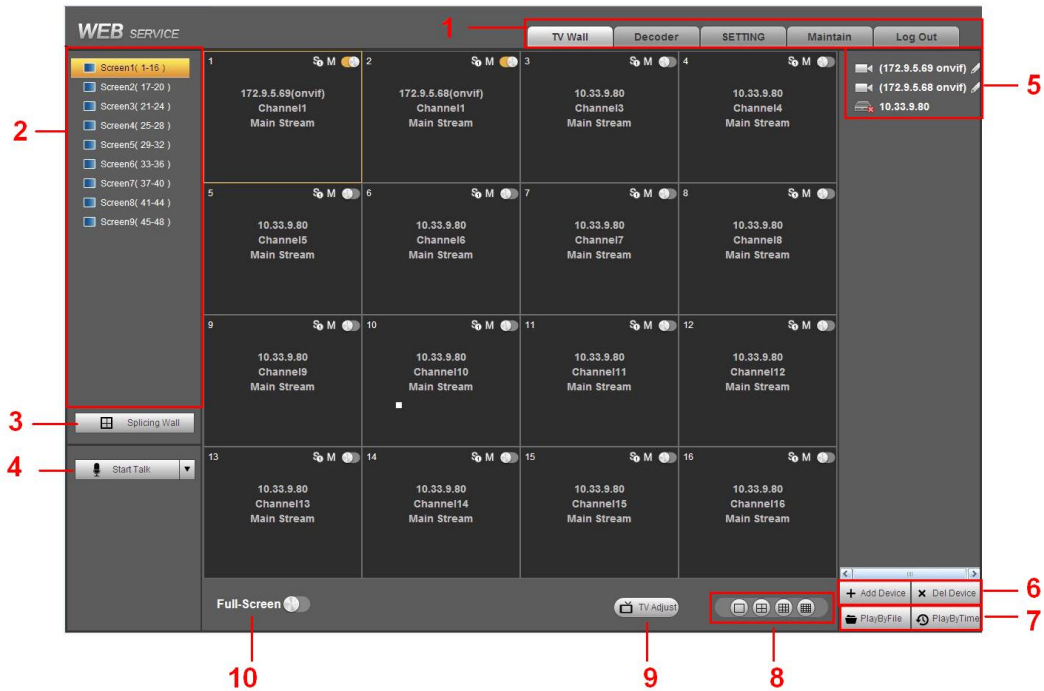

Figure 3-6

There are ten sections:

Section 1: System menu

There are system menu buttons. Please refer to chapter 3.8 decoder configuration, chapter 3.9 Setting, and chapter 3.11 logout for detailed information.

Section 2: Decode channel

Model	Decoded Channel	Note
1-channel 4K high definition series	16	The Web adopts the TV screen to display. There is 1 screen corresponding to 1 group output. You can use the one icon at the top left corner to select the screen. The first screen has 16-channel.
4-channel 4K high definition series	64	The Web adopts the TV screen to display. There are 4 screens corresponding to 4 groups output. You can use four icons at the top left corner to select the screen. Each screen has 16-channel.
1-channel high definition series	16	The Web adopts the TV screen to display. There is 1 screen corresponding to 1 group output. You can use the one icon at the top left corner to select the screen. The first screen has 16-channel.
4-channel high	28	The Web adopts the TV screen to display.

definition series		There are total 4 TV screens corresponding to 4 groups output. You can use the four icons at the top left corner to select the screen. The first TV screen has 16-channel; the screen 2 to screen 4 each has 4-channel.
9-channel high definition series	48	The Web adopts the TV screen to display. There are total 9 TV screens corresponding to 9 groups output. You can use the 9 icons at the top left corner to select the screen. The first TV screen has 16-channel; the screen 2 to screen 4 each has 4-channel.
16-channel high definition series	64	The Web adopts the TV screen to display. There are 16 screens corresponding to 16 groups output. You can use the 16 icons at the top left corner to select the screen. The screen each has 4-channel.

Section 3: Splicing wall.

Click  **Splicing Wall**, you can set splicing wall function. Please refer to chapter 3.4 for detailed information.

Section 4: Bidirectional talk

It realizes the bidirectional talk between the WEB and the decoder. Please click 

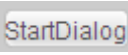
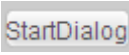
button of the  button to select corresponding bidirectional talk mode from the dropdown list. Click  button to begin bidirectional talk between the WEB and the decoder.

Section 5: Front-end device list

It is to display added front-end device, device encode list and front-end device status. The 4-channel 4K high definition series product supports local signal collection. There is 1 –channel local signal in the device list by default. See Figure 3-7.

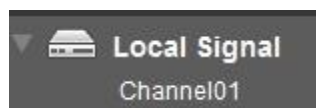

Figure 3-7

Section 6: Add/delete device

Add/delete front-end of the decoder.



Section 7: Playback

You can select playback by file or by time.

Section 8: Window split

There are four display modes: 1/4/9/16 window split. Take the first TV screen for an example: there are 16 options for single-window mode: channel 1, Channel 2.....channels 16. There are 4 options for four-window mode: 1-4ch, 5-8ch, 9-12ch, 13-16 ch. There are two options for nine-window mode: 1-9ch, 8-16ch. There is one option for 16-window mode: 1-16channel.

Single click and choose any decode channel to connect real-time decode output. Please see Figure 3-8.

1. Device Name
2. Front-end device IP address.
3. Front-end real-time monitor channel.
4. The real-monitor channel connection status between the decoder and the front-end and the stream mode such as main stream or sub stream.
5. : Enable main stream.
6.  Enable sub stream.
7. It is a button to control the connection between the decoder and the front-end. Click it to close or open video.

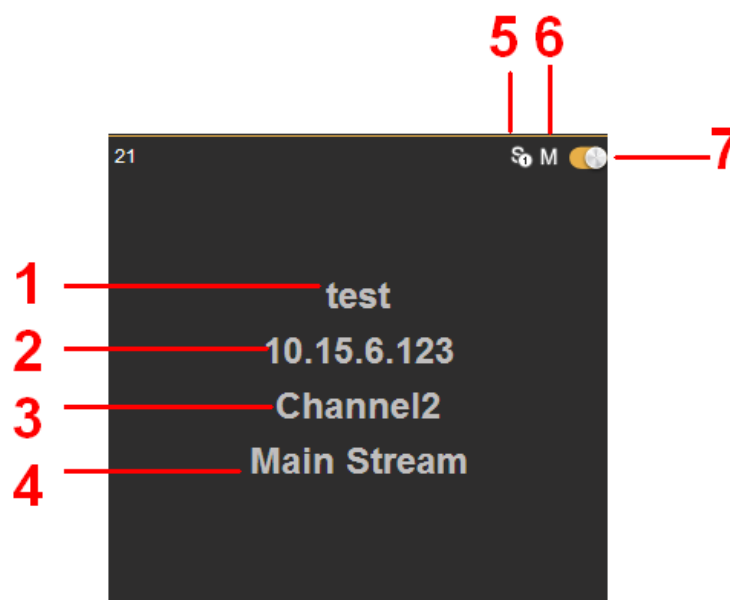

Figure 3-8

Section 9:TV adjust/Screens

- TV Adjust

It is not for splicing wall. It is for current screen only.

This function is for 4-channel 4K high definition and 1/4-channel high definition series only. The 1-channel 4K high definition series product does not support this function. It is to adjust margin. This function is valid for BNC output only. The margin value ranges from 0 to 100.

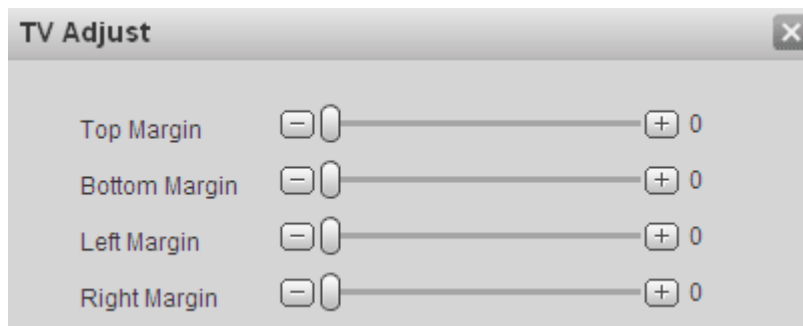



Figure 3-9

● **Screens**

This function is for 4-channel 4K high definition series product only.

Click , system pops up screen on-off button, system BLC mode and screen adjust interface. See Figure 3-10.

✧ **Screen Power**

The screen on-off interface is shown as below. Select a screen, you can see its color is yellow, and then click on/off button.

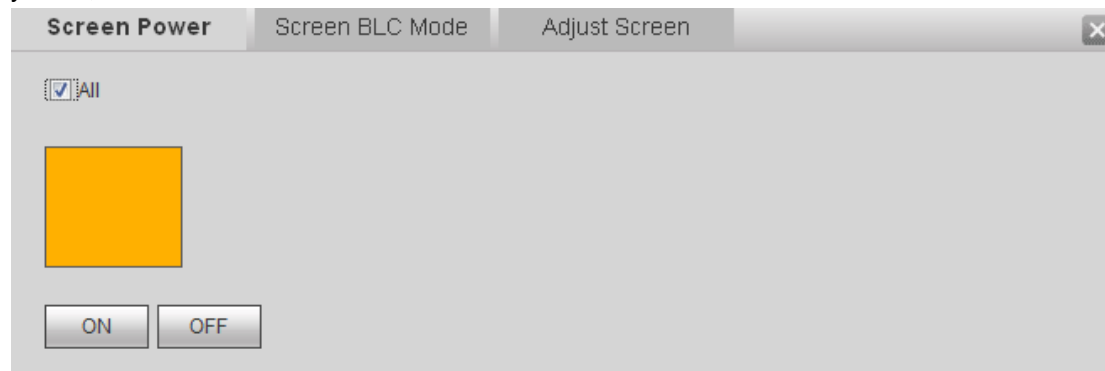

Figure 3-10

Before the screen on-off operation, please connect the RJ45 port of the 4-channel 4K high definition series product to the COM port of the monitor.

For the LCD from our company, 2 is to receive data, 3 is to send out data and 5 is GND.

RJ45 COM port of the 4-channel 4K high definition series product: 1 is to receive data, 8 is to send out data, 5 is GND.

Please connect the 1 of the device to the 3 of the LCD, 8 of the device to the 2 of the LCD, and 5 of the device to the 5 of the LCD. For the other cable, you can just cut off.

✧ **Screen BLC Mode**

Note

This function is for some screens only.

Click screen BLC mode, you can go to the following interface. Select one or more screen(s) or you can check ALL to select all screens and then click Switch mode button. See Figure 3-11.

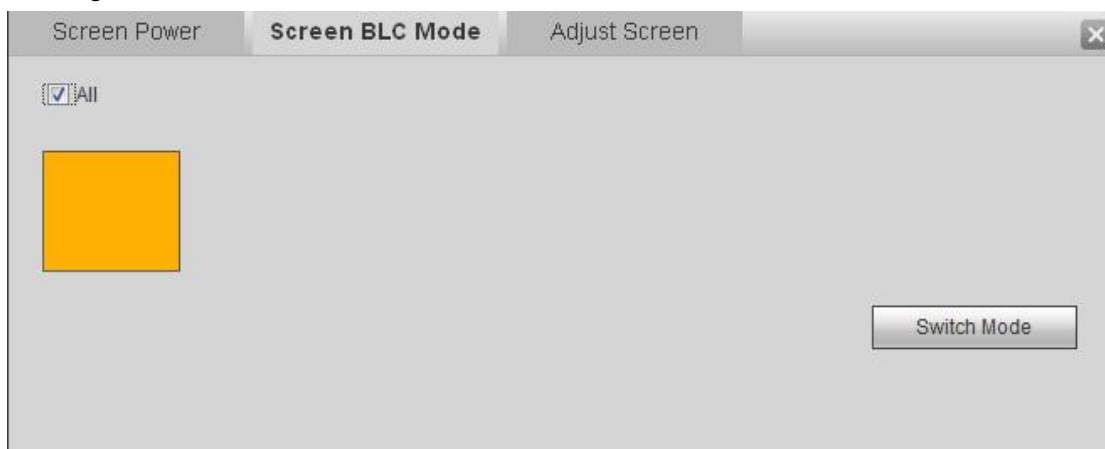

Figure 3-11

✧ Adjust Screen

Note

This function is for some screens only.

Click Adjust screen button, you can go to the following interface. Select a screen; you can see its color is yellow. Use “+” or “-” to adjust the parameters on the DVI,VGA,video mode. Please set according to the device hardware. See Figure 3-12.

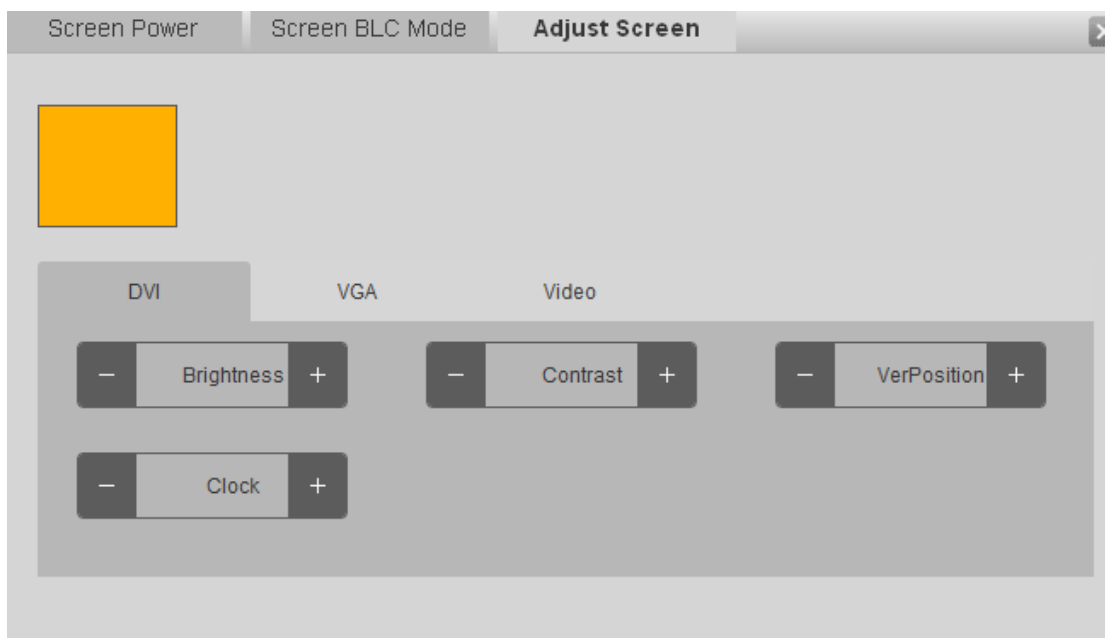

Figure 3-12

Section 10: Close full-screen monitor

It is to close all monitor channel of current TV screen.

3.4 Video Wall Splicing (Display Pane) Function

The video wall splicing function is to output several physical video walls (1-9 screens) to one screen and can be used as one screen (Such as Test1 in Figure 3-13).

The 4-channel 4K high definition series supports 1×1, 2×1, 1×2, 2×2 splicing mode.

The 4-channel high definition series supports 2×2 splicing mode.

The 9-channel high definition series supports 2×2, 2×3, 3×2, 2×4, 4×2, 3×3 modes.

The 16-channel high definition series supports 2×2, 2×3, 3×2, 2×4, 4×2, 3×3, 3×4, 4×3, 3×5, 5×3, 4×4 modes.

Important

The splicing video wall (display pane) can be used as one physical TV screen. It can share the device on the device tree and supports monitor enable/disable function. It does not support channel map and playback function.

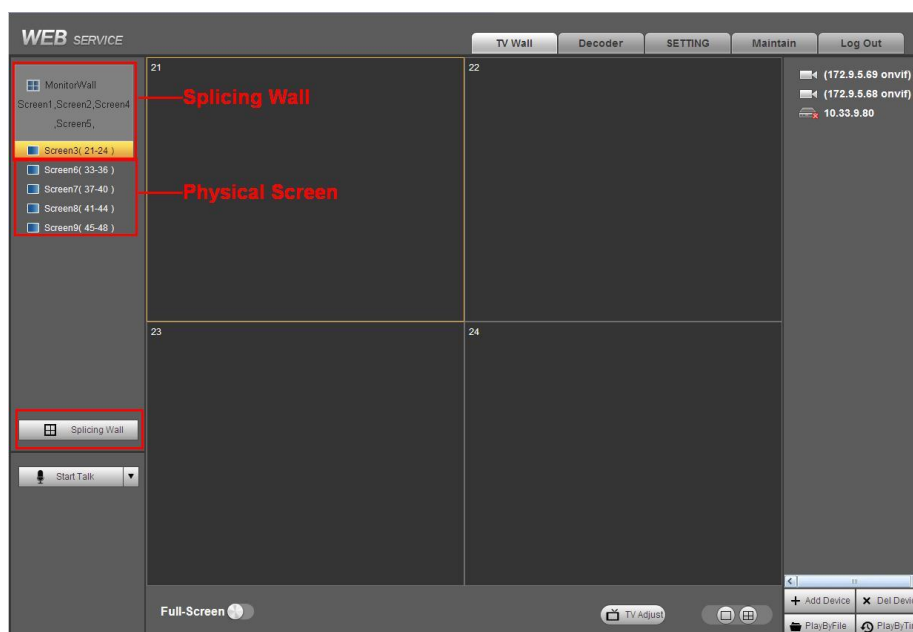

Figure 3-13

Please follow the contents below for a splicing video wall setup.

Step 1

In the main interface, click the Splice button  Splicing Wall on the left pane; you can see system pops up the following interface. See Figure 3-14.

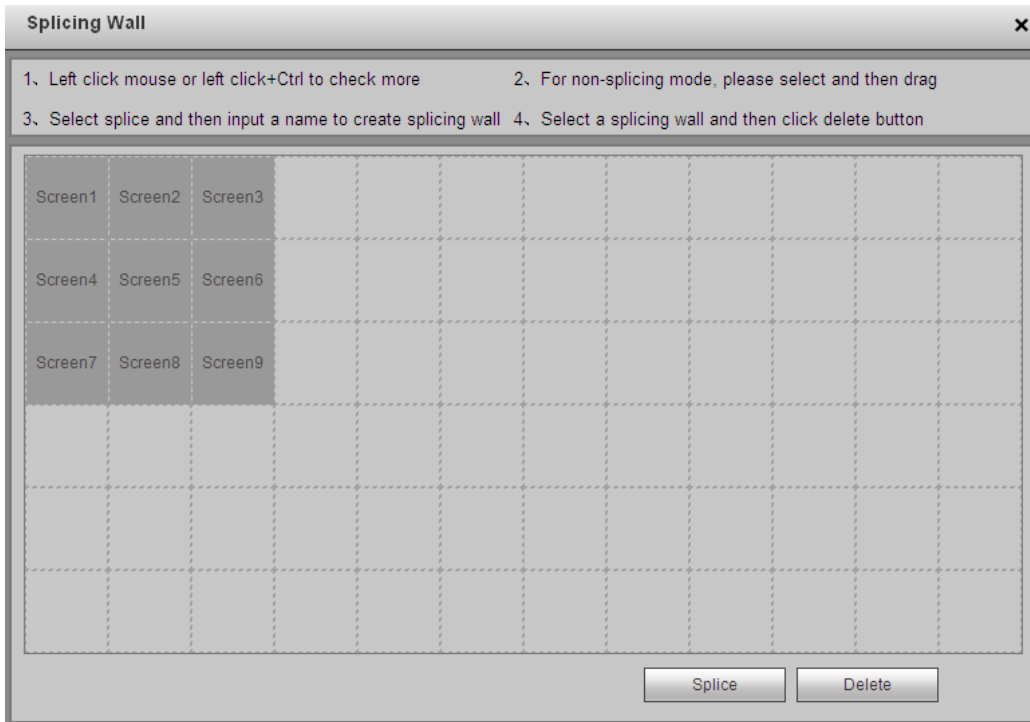

Figure 3-14

Step 2

Select screens. See Figure 3-15.

- Left click mouse to select one.
- Left click mouse +Ctrl button to select more screens.

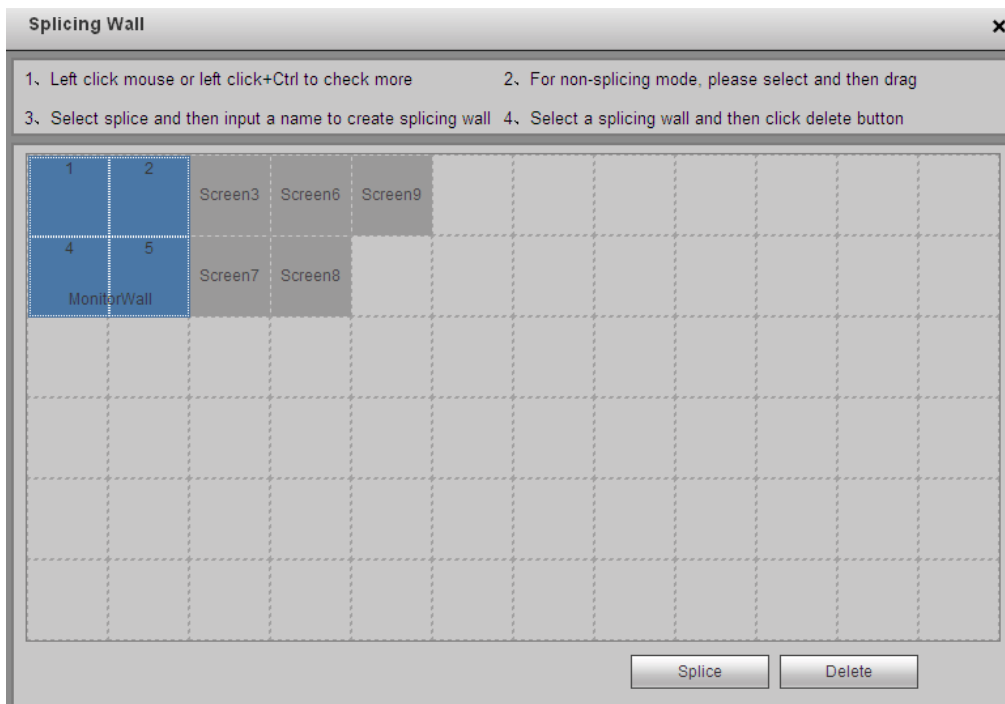



Figure 3-15

Step 3

Click  button, you can see an interface shown as in Figure 3-16.

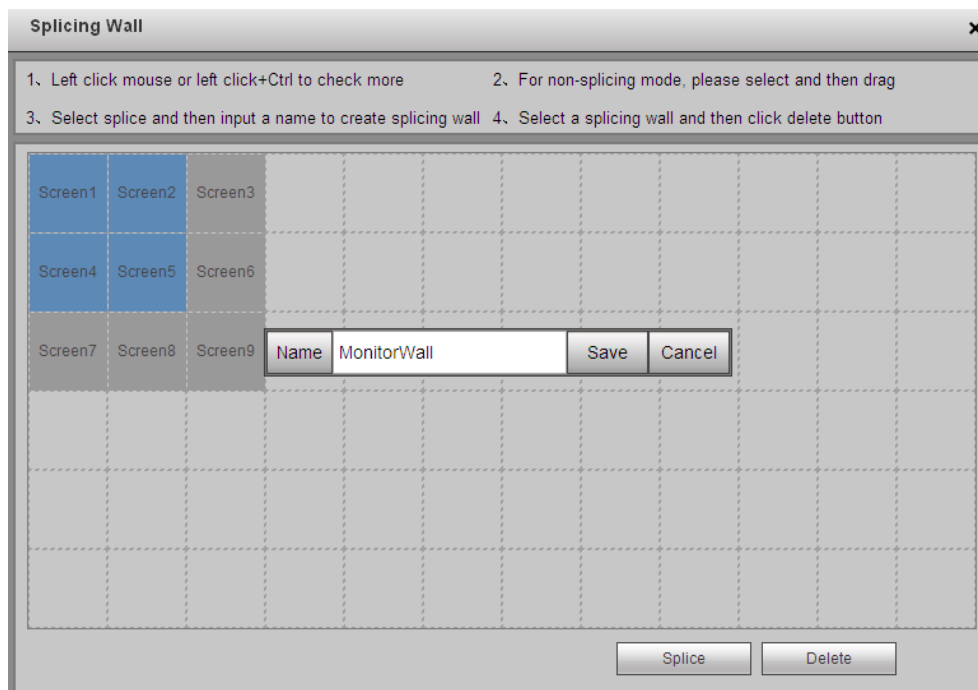

Figure 3-16

Step 4

In Figure 3-16, you can input customized splicing wall name. Click Save button to save current setup.

Step 5

Now you can close splicing wall interface and then go back to the main interface. The splicing wall can be used as a physical screen. It supports 1/4/9/16 split, add/delete device, open/close all-channel monitor.

Note

The general operation is the same as the physical screen. But for the splicing wall, there is no playback function and you can not control the corresponding physical screens of the splicing wall.

Cancel splicing wall

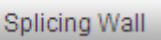
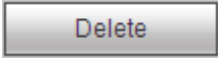
In the main interface, click the Splice button   on the left pane; you can go to Figure 3-14. Select a splicing wall first and then click  button, you can remove the selected splicing wall.

Note

The corresponding physical screens are off after you created a splicing wall. After you delete the splicing wall, the corresponding physical screens are off too.

3.5 Add /Remove Front-end Device

3.5.1 Add device

Click  button in the main window. System pops up the following dialogue box.

Here you need to input the front-end device information including manufacturer (Private, Onvif, and General), connection mode (TCP, UDP, AUTO) device name, device IP, port, device user name and password. See Figure 3-17.

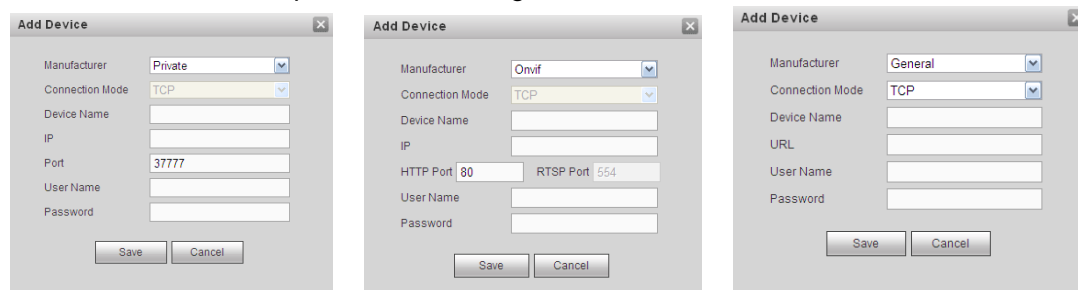

Figure 3-17

After inputting the corresponding information, please click OK button. You can see the device begins to connect the newly added front-end device. System auto lists the channel information after successful connection. For newly added private device, device displays as online. Double click the device; you can see it becomes offline. For Onvif and General device, system displays an icon only. You can just drag the icon to the screen. See Figure 3-18.

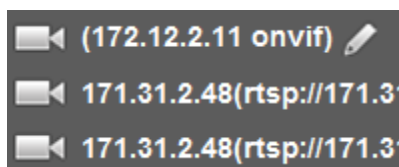



Figure 3-18

Click , you can modify device name.

3.5.2 Delete Device

Note

You can not delete the decoding device.

Select one front-end device and then click delete device button, system can remove it from the list.

3.6 Decode Channel Setup

Please select the output TV and position and then select the device channel in the device list. Double click channel name or drag the channel name to the destination position and then release. See Figure 3-19.

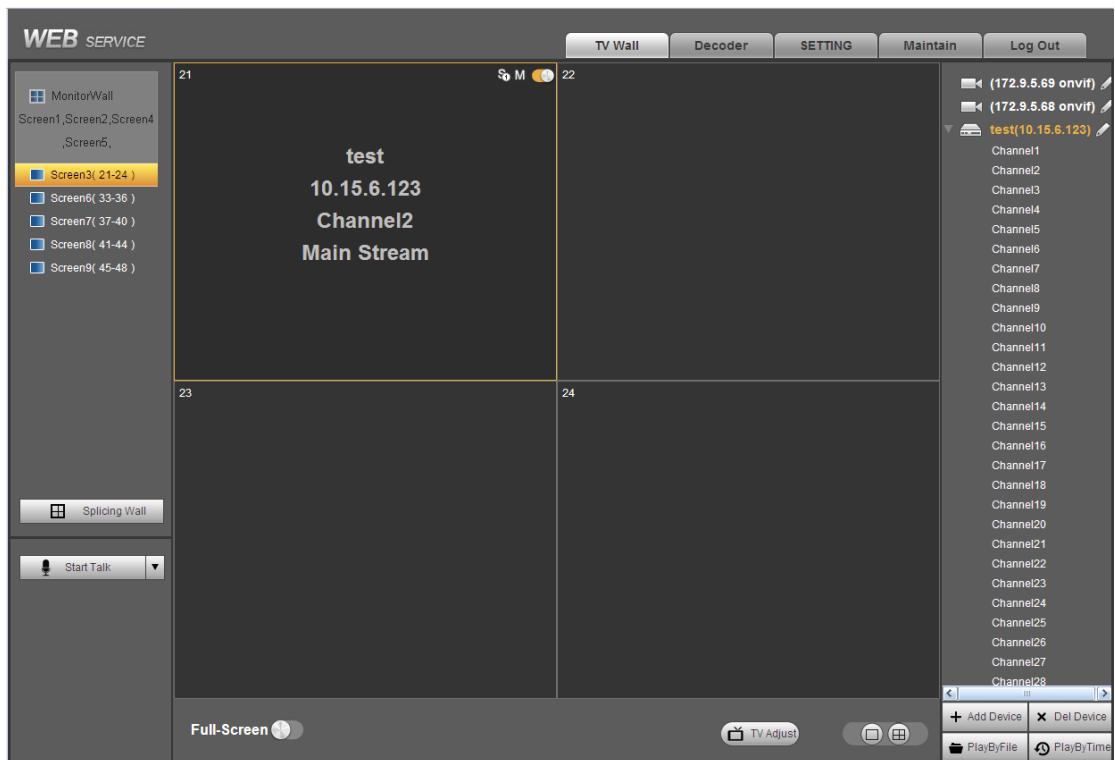

Figure 3-19

Right click channel of the front-end, you can enable main stream or sub stream. See Figure 3-20.

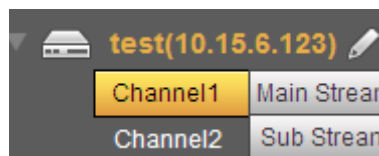

Figure 3-20

- : Open/close sub stream.
- : Open main stream.
- Screen on-off button. : Open. : Close.

3.7 File Playback and Time Playback

Note

Playback function is for private device only.

You can select a device you want to playback and then select the corresponding playback mode. There are two modes: file playback and time playback.

3.7.1 File Playback

Please select a online device first and then select playback by file button. You can see the following interface. See Figure 3-21.

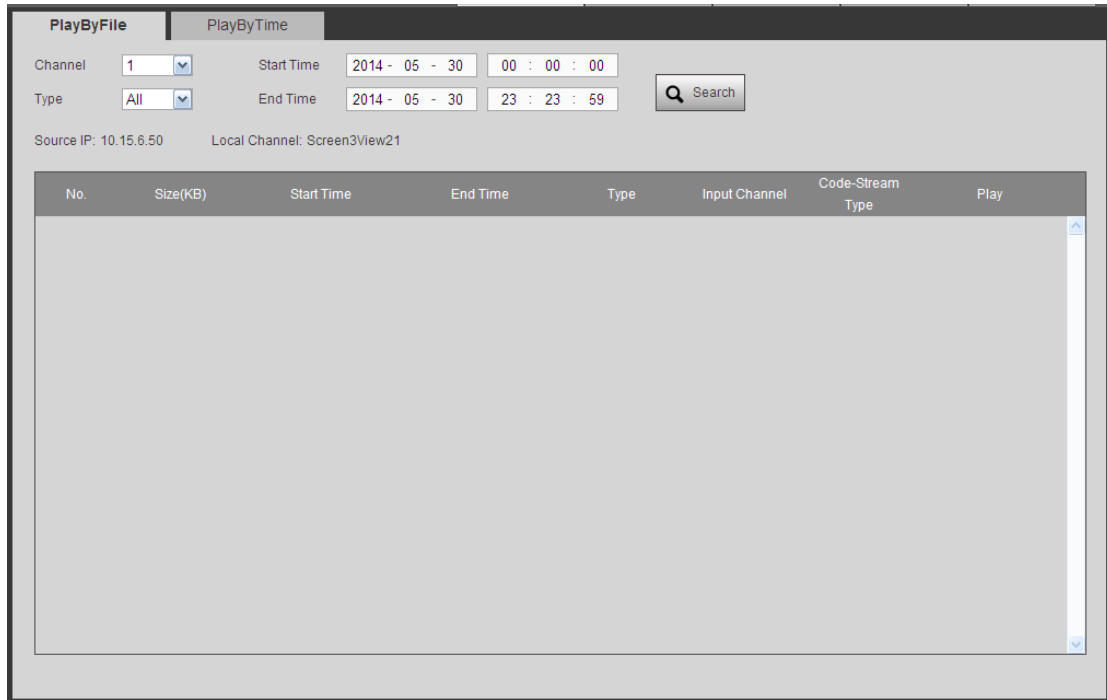

Figure 3-21

Please select the decode channel, record type and then select start time/end time, click search button, you can see an interface is shown as below. See Figure 3-22.

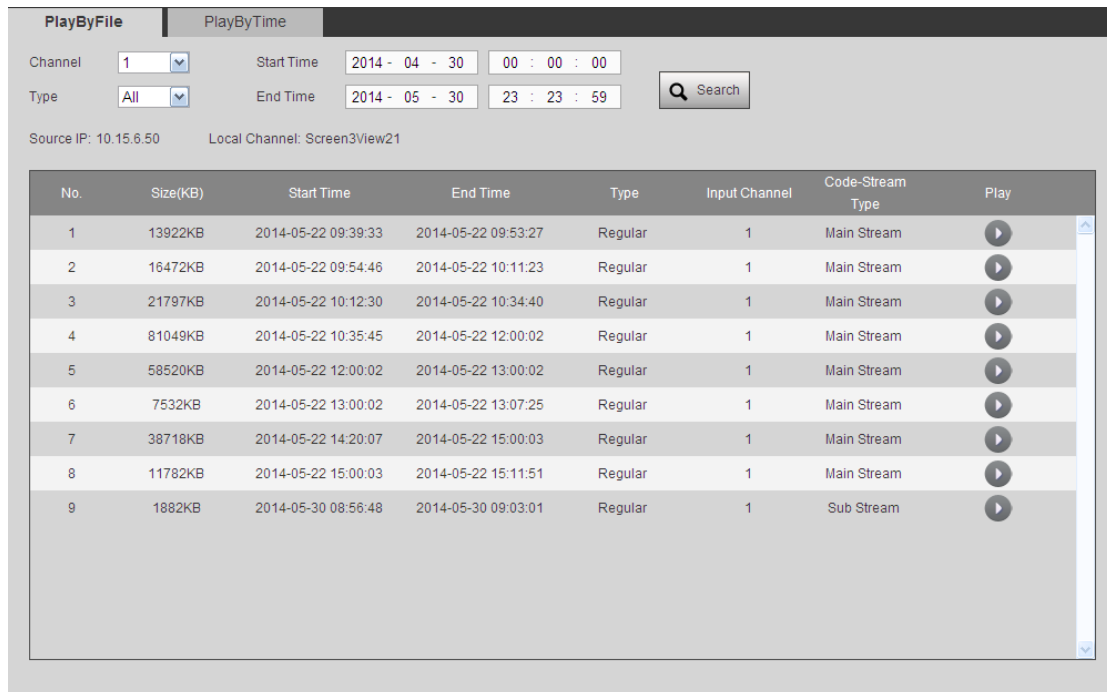



Figure 3-22

Select a record file and then click , you can see the following interface. See Figure 3-23.

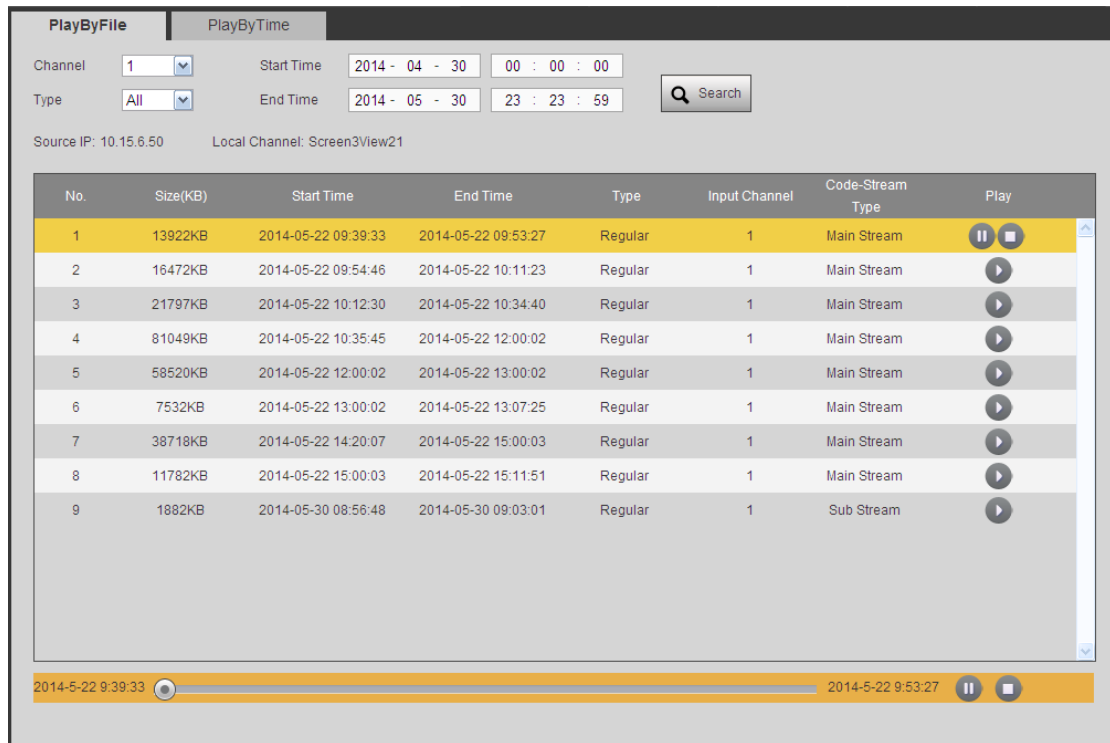

Figure 3-23

The main interface is shown as below. See Figure 3-24. Click the process bar to adjust file playback position. Or you can click button to play, pause, and stop.

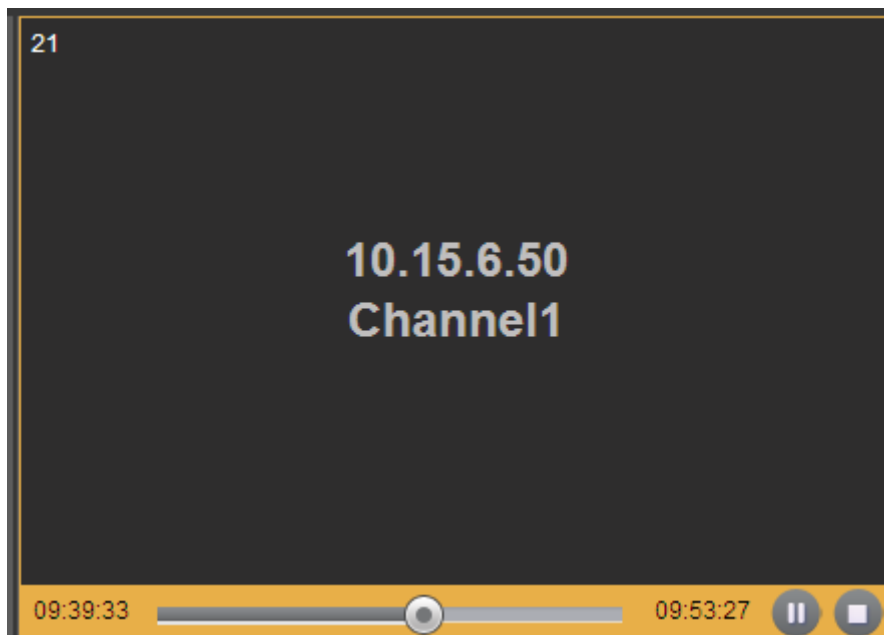

Figure 3-24

Double click decode channel, you can view in full screen.

The playback bar is shown as below. See Figure 3-25.

The three buttons ranges from left to the right are: playback, pause, and stop.



Figure 3-25

Note:

- If you searched device is offline, system prompts “Channel search failed” or “No record”.
- System max supports 4-channel playback at the same time.
- System can not playback the same camera of one device at different channels.

3.7.2 Time Playback

In Figure 3-21 or the main interface, click playback by time button, you can see an interface shown as in Figure 3-26.

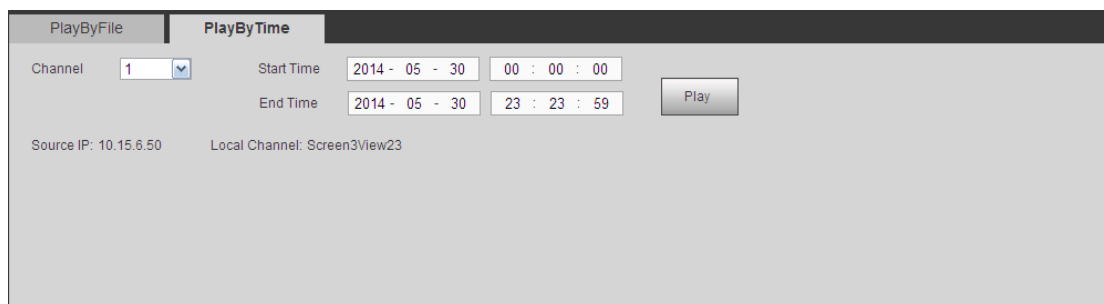
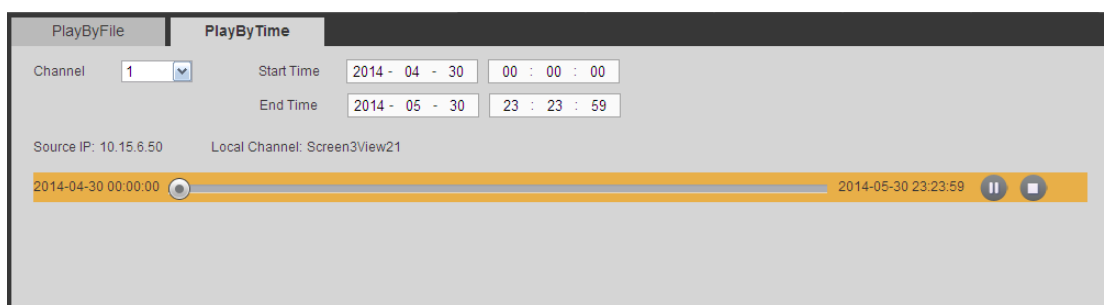

Figure 3-26

Please select corresponding time period and channel, and then click playback button, system can playback automatically.



The playback bar is the same with file playback mode.

Note:

TV window is shown as black if there is no record in current specified period.

3.8 Decoder

3.8.1 Decode Tour

Here you can set decode output channel and tour channel.

Decode tour means the decode channels of the decoder can bind the 32 channels on the network. It can display the 32 channels by the specified sequence and interval.

- 1) On the main menu, from decoder->decode tour; you can see the following interface. See Figure 3-27.

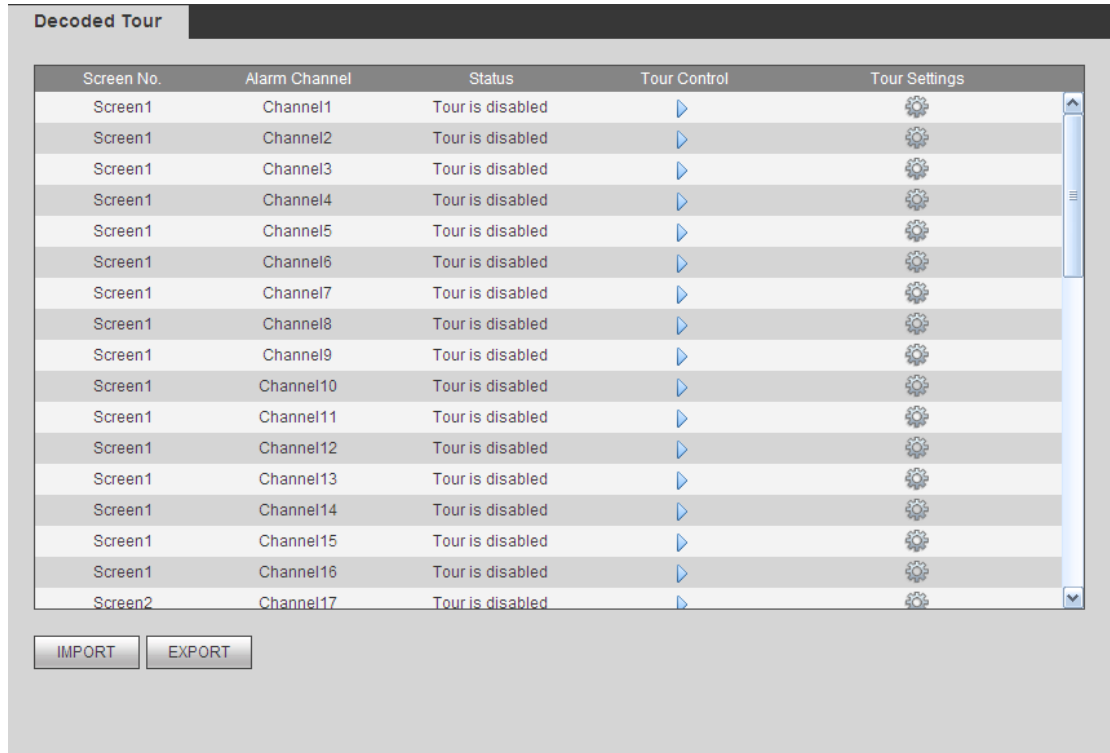



Figure 3-27

- 2) Double click a channel you want to set or click , you can set channel tour detailed information. See Figure 3-28.

Channel1Detailed Information

Tour Info

Network Signal Local Signal

Protocol Type: Private

Connection Mode: TCP

IP:

Port: 37777

Channel: 1

Code-Stream Type: Main Stream

Username:

Password:

Interval: 10 (10~99999)Second

Add Delete Modify

No.	Manufacturer	IP/URL	Port	Channel	Code-Stream Type	Interval	Delete

Save Refresh

Figure 3-28

Please refer to the following sheet to set tour information.

Parameter	Note
Protocol type	It includes: private, Onvif, General.
Connection mode	For different device modes, the connection mode may vary.
IP	Front-end device IP address.
Port	Default setup is 37777.
Channel	The channel of the front-end device.
Bit stream type	The bit stream type of the tour window. It includes the main stream and the sub stream.
User name	The user name of the remote device.
Password	The password of the remote device.
Interval	The tour interval.

In Figure 3-28, click Local Signal; you can see the following interface. See Figure 3-29.

Please note this function is for 4-channel 4K high definition series.

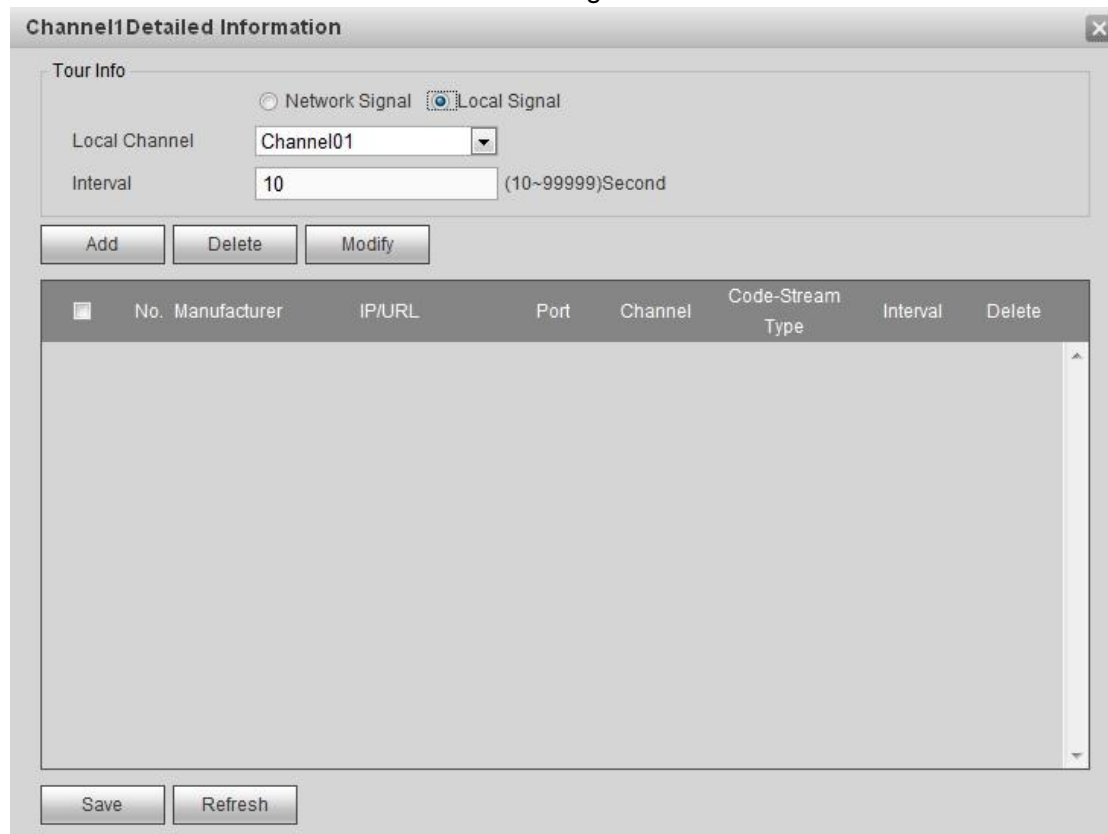



Figure 3-29

Please refer to the following sheet to set tour information.

Parameter	Note
Local Channel	Please select from the dropdown list.
Interval	It is to set tour interval.

- 3) Click add button to complete the add operation.
- 4) Click Save button.

5) Click  to enable tour.

- : Stop tour.
- : Pause tour.

3.8.2 Decode Output

On the main window, from decoder->decoded info, interface is shown as below. See Figure 3-30.

Here you can view current decode information.

- Status: Current channel working status. There are four statuses: Monitor/Playback/Tour/Idle.
- Resolution: Here you can view video resolution of current channel.

- FPS: You can view the frame rate of current channel.
- Data Flow: You can view the network data flow current channel received.
- Decode flow: You can view the output video flow current channel decoded.

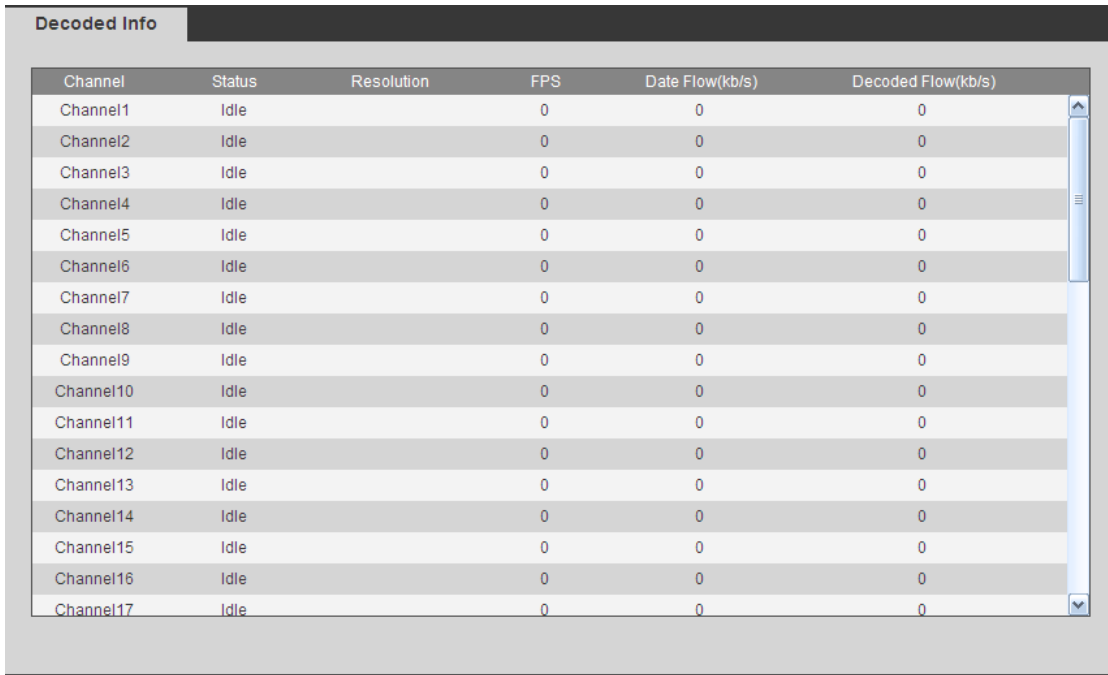

Channel	Status	Resolution	FPS	Date Flow(kb/s)	Decoded Flow(kb/s)
Channel1	Idle		0	0	0
Channel2	Idle		0	0	0
Channel3	Idle		0	0	0
Channel4	Idle		0	0	0
Channel5	Idle		0	0	0
Channel6	Idle		0	0	0
Channel7	Idle		0	0	0
Channel8	Idle		0	0	0
Channel9	Idle		0	0	0
Channel10	Idle		0	0	0
Channel11	Idle		0	0	0
Channel12	Idle		0	0	0
Channel13	Idle		0	0	0
Channel14	Idle		0	0	0
Channel15	Idle		0	0	0
Channel16	Idle		0	0	0
Channel17	Idle		0	0	0

Figure 3-30

3.8.3 Decode Strategy

On the main menu, from decoder->decoded policy, you can set the delay time of decoder in each decode channel, the buffer time is ms. See Figure 3-31.

- Channel number: The 1-channel 4K high definition series/1-channel high definition series supports 1-16-channel. The 9-channel high definition series supports 1-48-channel. The 4-channel 4K high definition series/ 16-channel high definition series supports 1-64-channel.
- Decode buffer time: The value ranges from 80ms to 480ms.

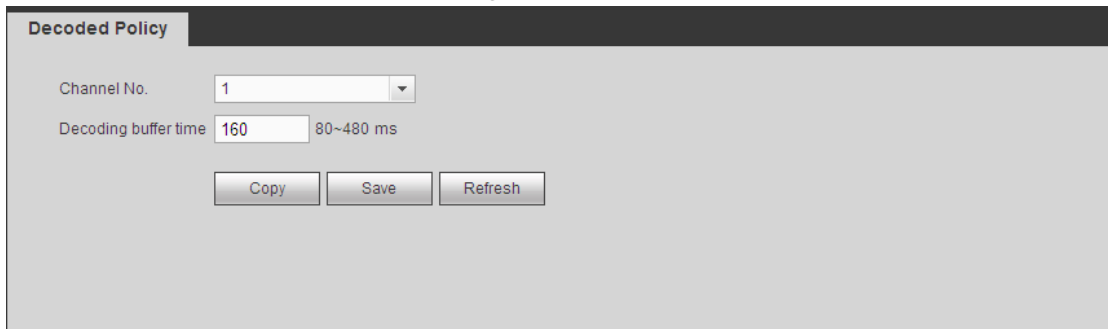

Decoded Policy

Channel No.

Decoding buffer time 80-480 ms

Figure 3-31

3.8.4 Screen Show

On the main menu, from decoder->screen No. overlay, you can see the following interface. See Figure 3-32.

It is for you to overlay device IP and TV number of current channel at the top left corner of current channel output interface. For 1-channel 4K high definition series product, the device IP and TV number is on the top left corner of the screen.

Important

This function is not for splicing video wall.

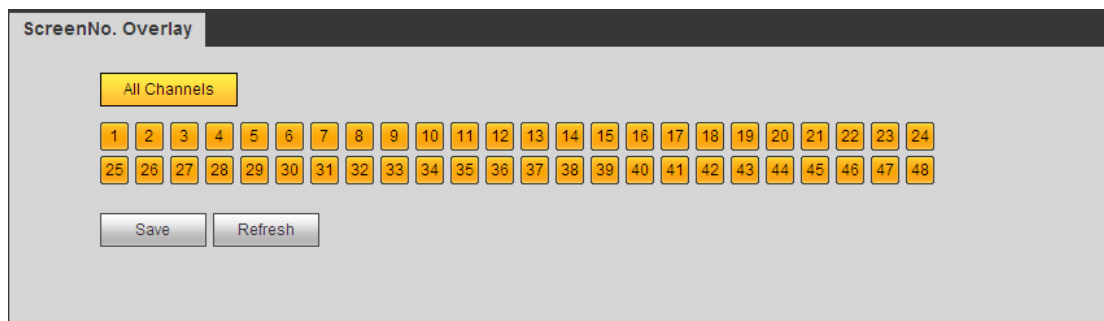

Figure 3-32

3.8.5 Output Options

Note

This function is for 1-channel 4K high definition series and 9-channel high definition series product only.

Here you can set output screen port. Please make sure it is the same as the connected port setup.

Select Screen No. and its corresponding port type from the dropdown list and then click Save button to complete setup. See Figure 3-33.

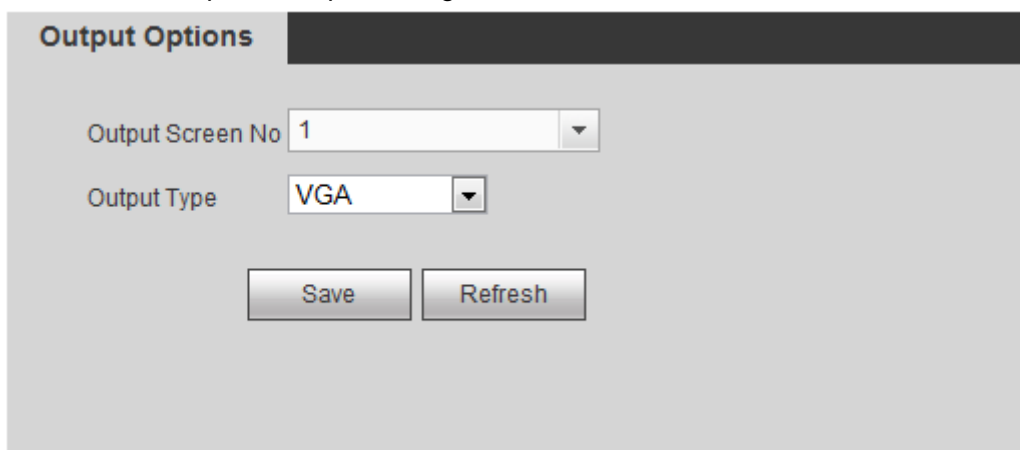

Figure 3-33

3.8.6 Background Color

Note

This function is for 4-channel 4K high definition series and 9/16-channel high definition series.

On the main menu, from decoder->Background color, you can see the following interface. See Figure 3-34.

It is to set the background color of the screen. There are two options: blue (default)/black.



Figure 3-34

3.8.7 Split Line

Note

This function is for 4-channel 4K high definition series and 9/16-channel high definition series.

On the main menu, from decoder->Split Line, you can see the following interface. See Figure 3-35.

Here you can set the split line for the decoded channels. The default setup is null.

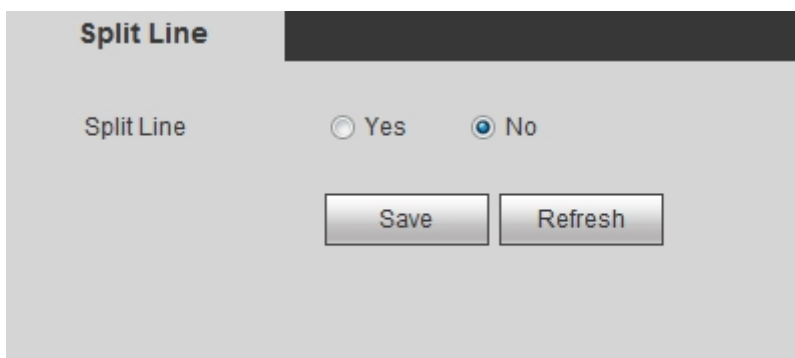

Figure 3-35

3.9 Setting

3.9.1 General

3.9.1.1 General

From Setting->General->General, you can see the following interface. See Figure 3-36.

- Device name: Input customized device name here.
- Device No. Default number is 8. The value ranges from 0 to 998.
- Language: It is to display device language.
- Video standard: It is to display system video standard: PAL/NTSC.

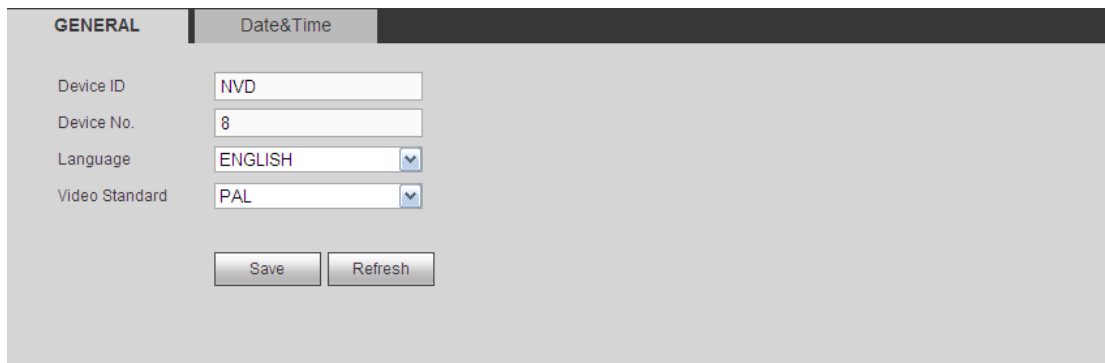

Figure 3-36

3.9.1.2 Date&Time

From Setting->General->Date&Time, the interface is shown as below. See Figure 3-37.

- Date format: There are three types: YYYY-MM-DD: MM-DD-YYYYY or DD-MM-YYYY.
- Time format: There are two options: 12-hour/24-hour.
- Date separator: There are three denotations to separate date: dot, beeline and solidus.
- DST: Here you can set DST time and date. Here you can set start time and end time by setting corresponding week setup or by setting corresponding date setup.
- NTP: It is to set NTP server information.

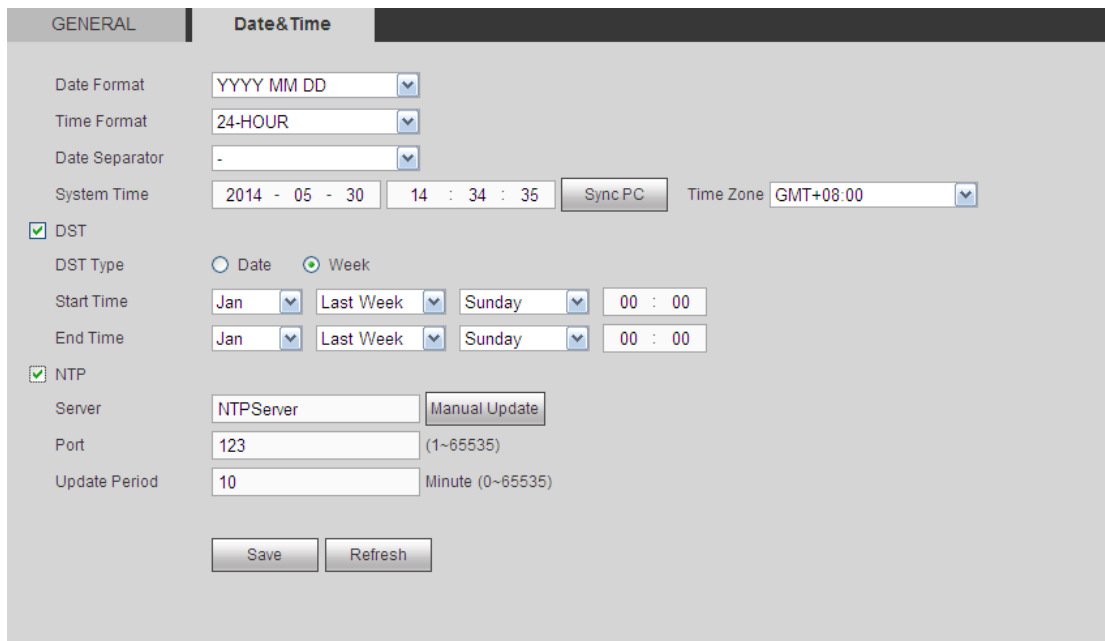

Figure 3-37

3.9.2 Network

3.9.2.1 TCP/IP

From Setting->Network->TCP/IP, TCP/IP interface is shown as below. See Figure 3-38 (1/4/9-channel high definition single-Ethernet card series) and Figure 3-39 (16-channel high definition dual-Ethernet card series).

- Network Mode:
 - ✧ Multiple-address mode: eth0 and eth1 operate separately. You can use the services such as HTTP, RTP service via eth0 or the eth1. Usually you need to set one default card (default setup is eth0) to request the auto network service from the device-end such as DHCP, email, FTP and etc. In multiple-address mode, system network status is shown as offline once one card is offline.
 - ✧ Network fault-tolerance: In this mode, device uses bond0 to communicate with the external devices. You can focus on one host IP address. At the same time, you need to set one master card. Usually there is only one running card (master card). System can enable alternate card when the master card is malfunction. The system is shown as offline once these two cards are both offline. Please note these two cards shall be in the same LAN.
 - ✧ Load balance: In this mode, device uses bond0 to communicate with the external device. The eth0 and eth1 are both working now and bearing the network load. Their network load are general the same. The system is shown as offline once these two cards are both offline. Please note these two cards shall be in the same LAN.
- Default card: Please select the network card first. Default port is Ethernet card1.

Please note the above function is for dual-Ethernet card series product only.

- Mode: There are two modes: static mode and the DHCP mode.
 - ✧ The IP/sub mask/gateway are null when you select the DHCP mode to auto search the IP.
 - ✧ If you select the static mode, you need to set the IP/submask/gateway manually.
 - ✧ If you select the DHCP mode, you can view the IP/submask/gateway from the DHCP.
 - ✧ If you switch from the DHCP mode to the static mode, you need to reset the IP parameters.

Besides, IP/submask/gateway and DHCP are read-only when the PPPoE dial is OK.

- MAC address: The host in the LAN can get a unique MAC address. It is for you to access in the LAN. It is read-only.
- IP Version: There are two options: IPv4 and IPv6. Right now, system supports these two IP address format and you can access via them.
- IP address: Here you can use up/down button (▲▼) or input the corresponding number to input IP address. Then you can set the corresponding subnet mask the default gateway.
- Default gateway: Here you can input the default gateway. Please note system needs to check the validity of all IPv6 addresses. The IP address and the default gateway shall be in the same IP section. That is to say, the specified length of the subnet prefix shall have the same string.
- Preferred DNS server: DNS server IP address.
- Alternate DNS server: DNS server alternate address.

Note

For IPv6, the IP address, default gateway, preferred DNS, alternate DNS shall be 128-digit and shall be left in blank.

TCP/IP	Port	HTTPS
Mode	<input checked="" type="radio"/> Static <input type="radio"/> DHCP	
MAC Address	90 . 02 . A9 . 05 . D6 . E4	
IP Version	IPv4	
IP Address	10 . 15 . 6 . 144	
Subnet Mask	255 . 255 . 0 . 0	
Default Gateway	10 . 15 . 0 . 1	
Preferred DNS	8 . 8 . 8 . 8	
Alternate DNS	8 . 8 . 4 . 4	
<input type="button" value="Save"/> <input type="button" value="Refresh"/>		

Figure 3-38

TCP/IP	Port	HTTPS
Network Mode	Multi-address	
Default Card	Ethernet Card1	
Ethernet Card	Ethernet Card1	<input type="button" value="Default Card"/>
Mode	<input checked="" type="radio"/> Static <input type="radio"/> DHCP	
MAC Address	20 . 32 . 04 . 01 . 50 . 37	
IP Version	IPv4	
IP Address	171 . 5 . 14 . 51	
Subnet Mask	255 . 255 . 255 . 0	
Default Gateway	171 . 5 . 14 . 1	
Preferred DNS	8 . 8 . 8 . 8	
Alternate DNS	8 . 8 . 4 . 4	
<input type="button" value="Save"/> <input type="button" value="Refresh"/>		

Figure 3-39

3.9.2.2 Port

From Setting->Network->port, port interface is shown as below. See Figure 3-40.

- Max connection: It is the max Web connection for the same device. The value ranges from 1 to 120. The default setup is 120.
- TCP port: The default value is 37777. You can input the actual port number if necessary.
- UDP port: The default value is 37778. You can input the actual port number if necessary.
- HTTP port: The default value is 80. You can input the actual port number if necessary.
- HTTPS: The default value is 443. You can input the actual port number if necessary.

TCP/IP	Port	HTTPS
Max Connection	<input type="text" value="10"/>	(0~10)
TCP Port	<input type="text" value="37777"/>	(1025~65535)
UDP Port	<input type="text" value="37778"/>	(1025~65535)
HTTP Port	<input type="text" value="80"/>	(1~65535)
HTTPS Port	<input type="text" value="443"/>	(128~65535)

Figure 3-40

3.9.2.3 HTTPS

In this interface, you can set to make sure the PC can successfully login via the HTTPS. It is to guarantee communication data security. The reliable and stable technology can secure the user information security and device safety. See Figure 3-41.

Note

- You need to implement server certificate again if you have changed device IP.
- You need to download root certificate if it is your first time to use HTTPS on current PC.

Figure 3-41

3.9.3 RS232

3.9.3.1 RS232

From Setting->RS232->RS232, you can see RS232 interface is shown as below. See Figure 3-42.

- Function: There are various devices for you to select. Console is for you to use the COM or mini-end software to upgrade or debug the program. The control keyboard is for you to control the device via the special keyboard. Transparent COM (adapter) is to connect to the PC to transfer data directly. Protocol COM is for card overlay function. Network keyboard is for you to use the special keyboard to control the device. PTZ matrix is to connect to the peripheral matrix control.
- Baud rate: You can select proper baud rate.
- Data bit: You can select proper data bit. The value ranges from 5 to 8.
- Stop bit: There are two values: 1/2.
- Parity: There are five choices: none/odd/even/space mark.

System default setup is:

- Function: Console
- Baud rate:115200
- Data bit:8
- Stop bit:1
- Parity: None

Note

- 1-channel 4K high definition series product has no RS232 function. It only has transfer COM function.
- 4- channel 4K high definition series product default setup: Baud rate:115200(read-only), data bit: 8, stop bit: 1, parity: none.

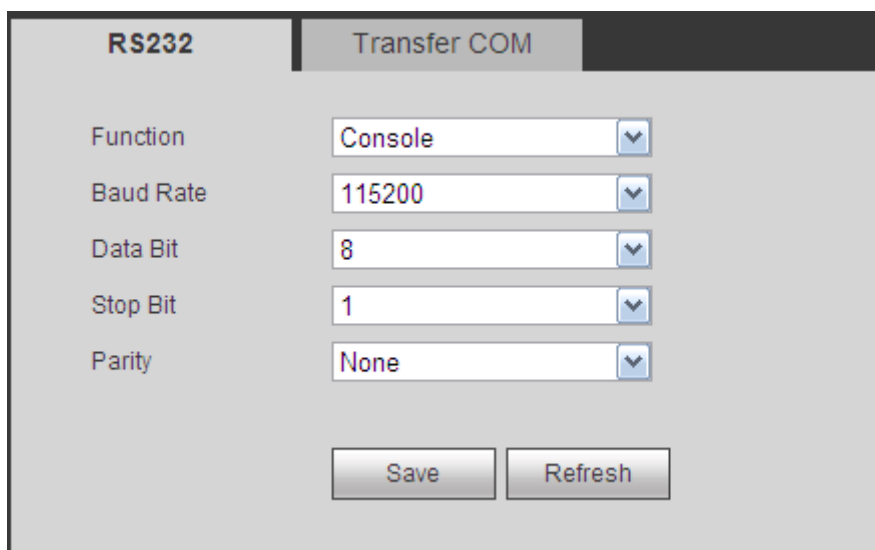

Figure 3-42

3.9.3.2 Transfer COM

From Setting->RS232->transfer COM, you can see the interface is shown as in Figure 3-43.

After you input local COM and remote COM information, you can control the camera. Click the Add button to complete.

Important

The local COM and the remote COM parameter shall be the same; otherwise you can not control the camera!

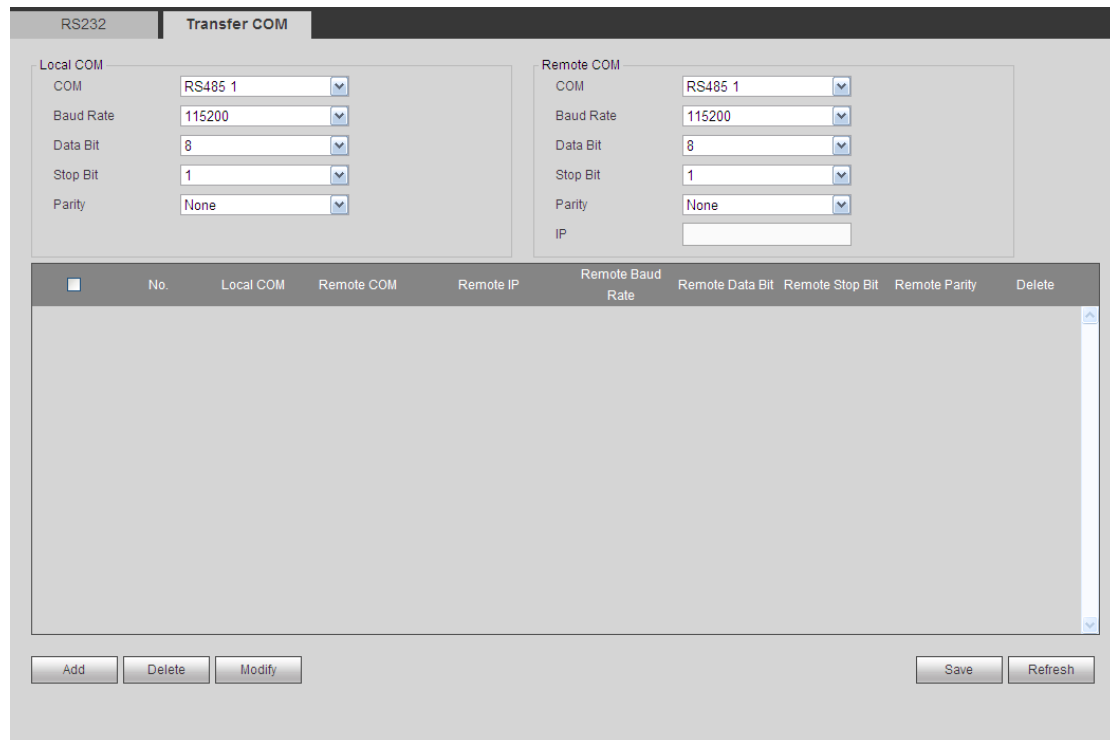

Figure 3-43

Transparent Forwarding Connection

Connect speed dome to encoder or DVR via RS485. The decoder can add encoder or DVR via network. Connect network keyboard or DVR to the decoder via RS485. See Figure 3-44.

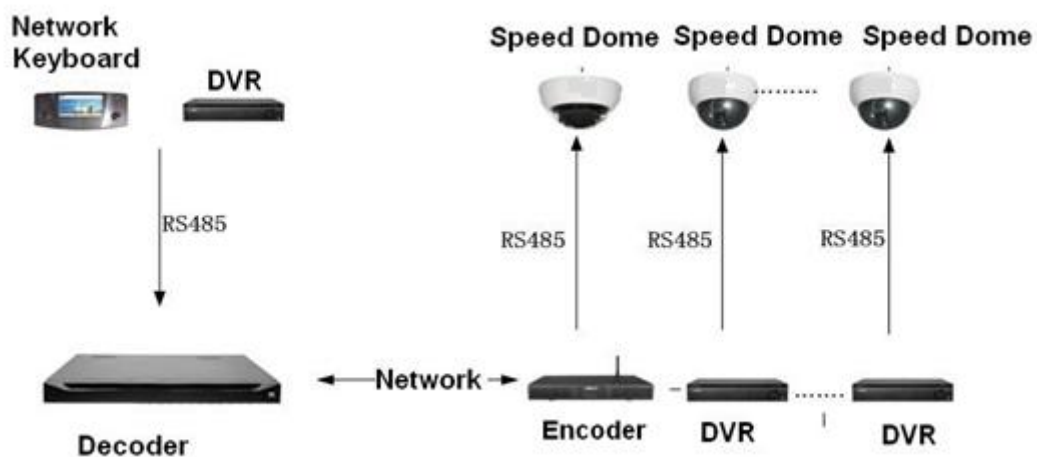

Figure 3-44

- 1) The dial switch address of the analog speed dome shall not be the same.
- 2) After you connected the analog speed dome to the encoder via RS485, please connect the corresponding AB cable. See Figure 3-45.



Figure 3-45

- 3) Please refer to Figure 3-46 to connect the decoder to the network keyboard or DVR via RS485.
 - ✧ Connect the R0+ to T0+ of the decoder directly and then connect to the A cable of the network keyboard or DVR.
 - ✧ Connect the R0- to T0- of the decoder directly and then connect to the B cable of the network keyboard or DVR.

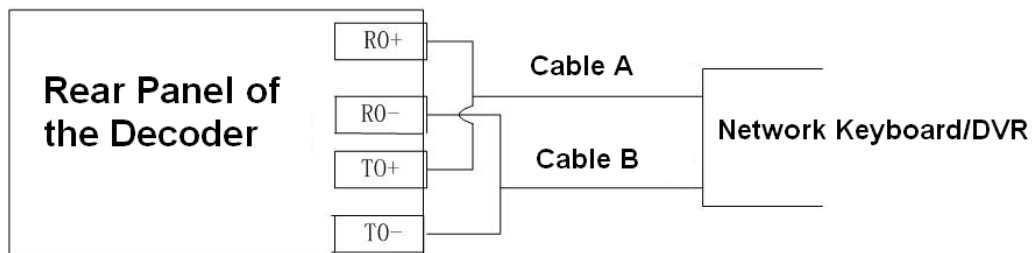

Figure 3-46

- 4) When you set the PTZ setup of the network keyboard or the DVR, please make sure the baud rate setup shall be the same with the setup of the analog speed dome.
- 5) When you set the PTZ setup of the network keyboard, DVR, encoder, please make sure the protocol setup shall be the same.

Transparent Forwarding Operation Steps

- 1) Set network speed dome. Set the baud rate of the network speed dome. When the 5/6 is up, the baud rate is 9600. When the 5 is down and 6 is up, the baud rate is 4800. When the 5 is up and 6 is down, the baud rate is 2400. When the 5/6 is down, the baud rate is 1200. Here we set baud rate as 2400.
- 2) Set encoder or DVR. When you connect network speed dome to the encoder or DVR via RS485, you need to set PTZ setup. See Figure 3-47.



Figure 3-47

- 3) Set decoder. Please refer to chapter 3.10.3 transparent forwarding to set.
- 4) Connect network keyboard or DVR to the decoder via RS485.

✧ **About network keyboard setup**

From user menu-remote control, input 0+PT to go to PTZ setup. Here you can set protocol, address, baud rate, data bit, stop bit, parity and etc. See Figure 3-48.

Important

When you connect network keyboard to decoder via RS485, please make sure the network keyboard setup is the same as the PTZ setup of the encoder. Otherwise you can not control.

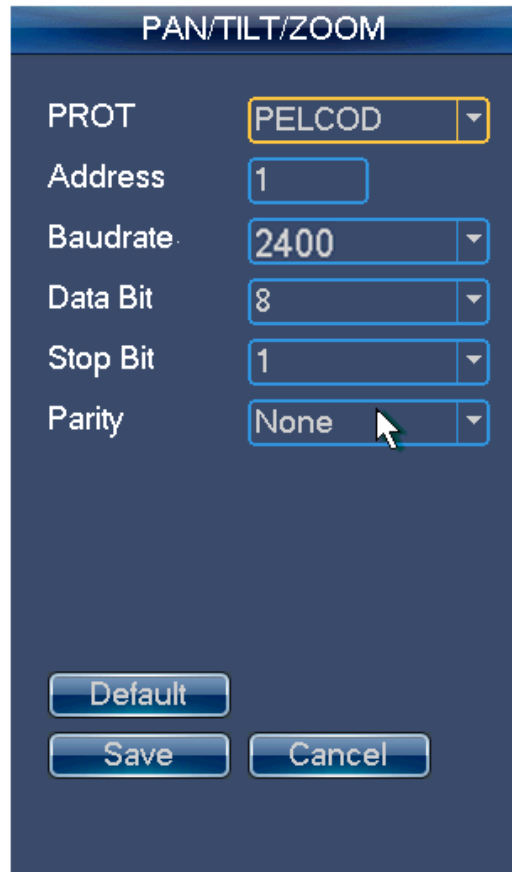

Figure 3-48

✧ **About DVR Setup**

From the main menu, System->PTZ, you can set corresponding baud rate, protocol, address, data bit, stop bit, parity and etc.

- 5) After you set, please click the corresponding network keyboard or DVR input channel, you can go to the PTZ interface to control the network speed dome PTZ operation.

3.9.3.3 Screen Control

Note

This function is for 4-channel 4K high definition series product.

From Setting->RS232->Screen control, you can go to the following interface. See Figure 3-49.

Before the operation, please connect the RS232 port of the RJ45 port of the device to the RJ45 port of the screen.

- Name; The corresponding TV wall.
- Device type: It is to display device type such as LCD, DLP.
- Control protocol: It is the control protocol of the display device.
- Baud rate: Baud rate of the communication COM protocol.
- Data bit: Data bit of the communication COM protocol.
- Stop bit: Stop bit of the communication COM protocol.

- Parity: Parity value of the communication COM protocol.
- Address code: It is corresponding to the address code of display device.
- Screen No.:It is the corresponding screen number.

row-column	Address Code	Screen No.	Screen ControlID
1_1	11	1	0

Figure 3-49

3.9.4 Alarm

3.9.4.1 Alarm

The 16-channel high definition series product does not support alarm function.

From Setting->Alarm->Alarm, the alarm interface is shown as below. See Figure 3-50.

- Enable: You need to draw a circle here so that system can detect the alarm signal.
- Alarm in: Here is for you to select channel number.
- Type: Normal open or normal close.
- Period: Click set button, you can see an interface is shown as in Figure 3-51. There are max 6 periods in one day.
- Alarm Out: Enable alarm activation function. You need to select alarm output port so that system can activate corresponding alarm device when alarm occurs.
- Latch: System can delay the alarm output for specified time after alarm ended. The value ranges from 10 seconds to 300 seconds.
- Latch: System can delay the alarm output for specified time after alarm ended. The value ranges from 10 seconds to 300 seconds.
- Tour: Check the box here to enable this function. It is to set main TV output of the tour channel when an alarm signal occurred.
- Copy: It is a shortcut menu button. You can copy current channel setup to one or more (all) channels.
- Save: You can click save button after you complete setup for one channel, or you can complete the whole setups and then click save button.

- Refresh: Click this button to get device latest configuration information.

The screenshot shows the 'Alarm Info' configuration page. It includes a 'Setup' button, an 'Anti-dither' field set to 5, and a 'Type' dropdown set to 'Normal Open'. There are three checked options: 'Enable', 'Alarm Out', and 'Tour'. 'Alarm Out' has a value of 1, and 'Tour' has a value of 1. The 'Latch' field is set to 10. At the bottom, there are 'Copy', 'Save', and 'Refresh' buttons.

Figure 3-50

The 'Period' dialog box shows a dropdown menu set to 'Friday' and a 'Copy' button. Below are six rows, each with a checkbox and a time range field (00 : 00 - 24 : 00). The first row has a checked checkbox. At the bottom are 'Save' and 'Cancel' buttons.

Figure 3-51

3.9.4.2 Alarm Info

From Setting->Alarm->Alarm info, alarm info interface is shown as in Figure 3-52.

- External alarm: It is an alarm from external alarm device.
- DSP alarm: It is video format alarm. For example, your decoder is PAL while you connected front-end device is NTSC, which can generate a DSP alarm.

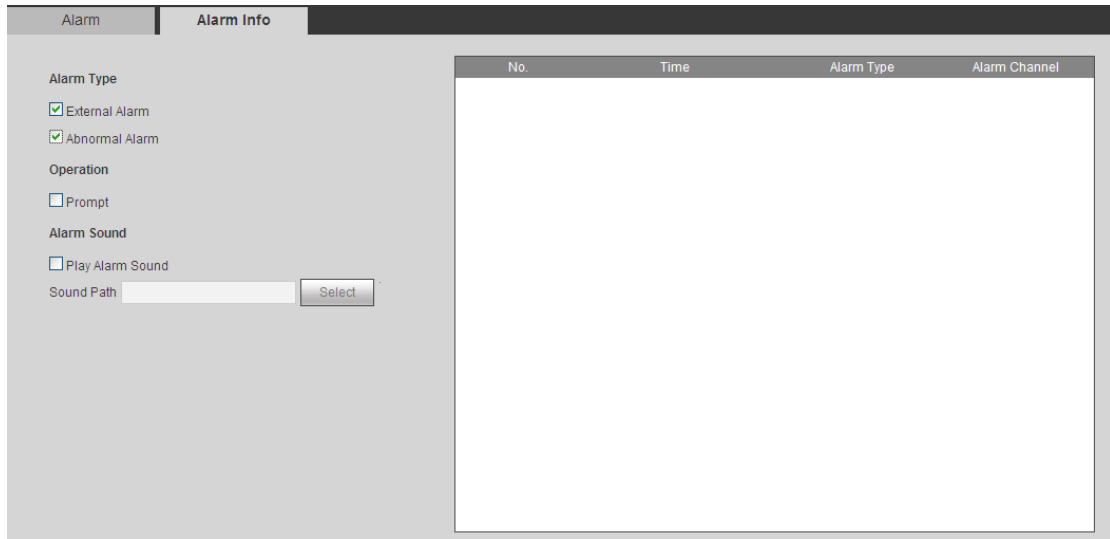

Figure 3-52

3.9.5 Resolution

From Setting->Resolution, the resolution interface is shown as below. See Figure 3-53. Resolution: It is to set the decoder resolution. It refers to the screen output resolution. Right now there are four options: 1280*1024, 1280*720, 1920*1080, and 1024*768. 1/4-channel 4K high definition series product supports 3840×2160 extra high definition output.

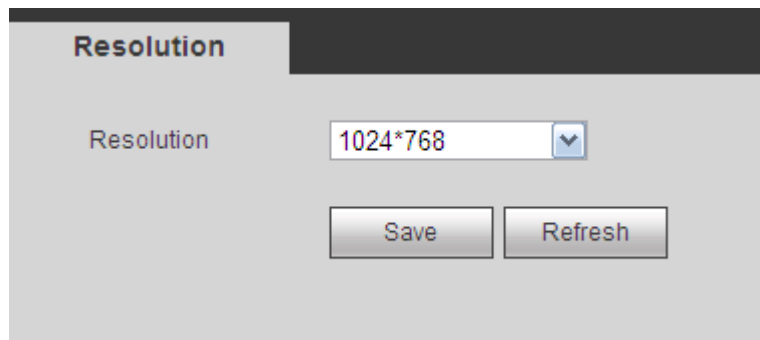

Figure 3-53

3.9.6 Account

From Setting->Account, here you can add, remove user or modify password. See Figure 3-54.

User

System default user name includes:

- User name: **admin**, password: **admin**;
- User name: **888888**, password: **888888**;
- User name: **666666**, password: **666666**;
- User name: **default**, password: **default**. Please note it is the hidden user.

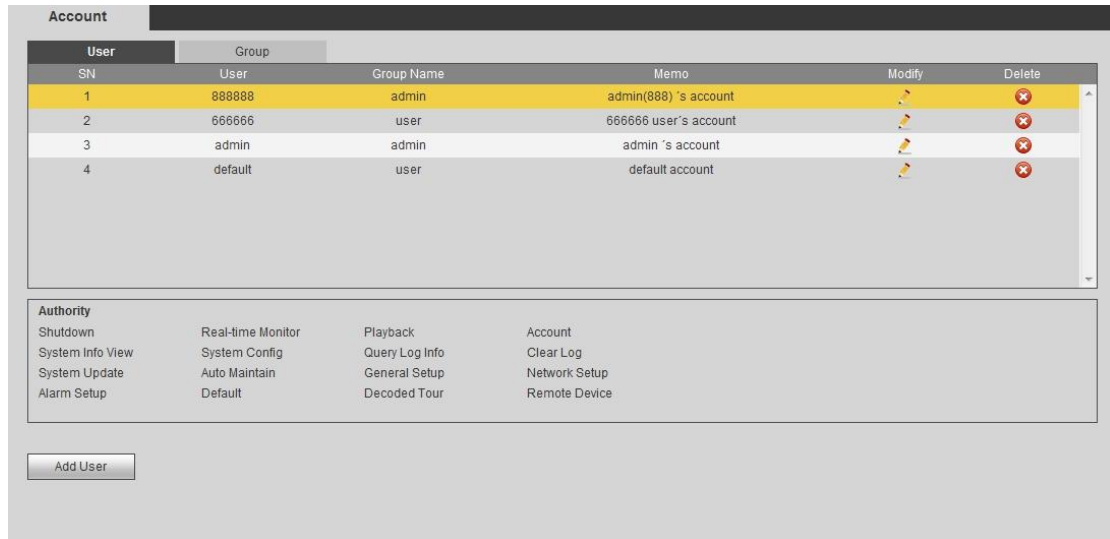

Figure 3-54

Add User

Click add user button, the interface is shown as in Figure 3-55.

Please input the user name, password, select the group it belongs to from the dropdown list. Check the reusable button so that multiple users can use the same account to login at the same time.

Then you can check the corresponding rights for current user.

For convenient user management, usually we recommend the general user right is lower than the admin account.

Click Save button to complete the setup.

Add User

User Name

Reuseable

Password

Low Middle High

Confirm Password

Group

Memo

Authority

System

- All
- Shutdown
- Account
- Query Log Info
- Auto Maintain
- Alarm Setup
- Remote Device
- Real-time Monitor
- System Info View
- Clear Log
- General Setup
- Default
- Playback
- System Config
- System Update
- Network Setup
- Decoded Tour

Figure 3-55

Modify User

In Figure 3-54, Click Modify button; you can change current user memory information, group, password and authorities. See Figure 3-56.

Figure 3-56

Modify Password

In Figure 3-56, check Modify password button, please input old password and then input the new password twice to complete the setup. Click OK button to save.

The password shall be 1-6-digit. The space at the front or the last space is invalid. The space shall be in the middle. For the user of the account right, it can change the password of other user.

Group

Click Group button, the interface is shown as below. Here you can add/delete group, or change group password and etc. See Figure 3-57.

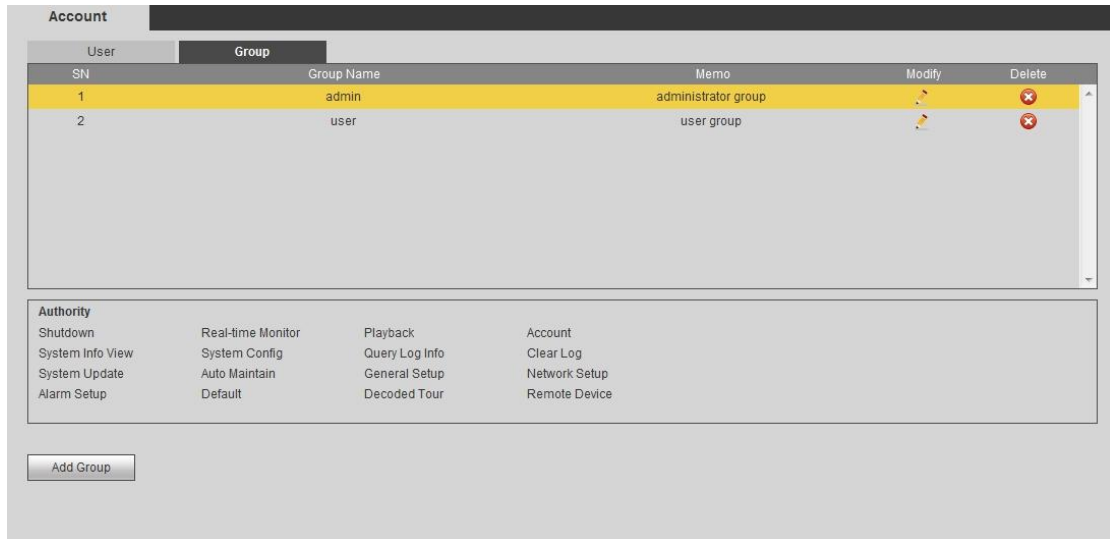

Figure 3-57

Add Group

Click add group button, the interface is shown as below. See Figure 3-58.

Here you can input group name and then input some memo information if necessary.

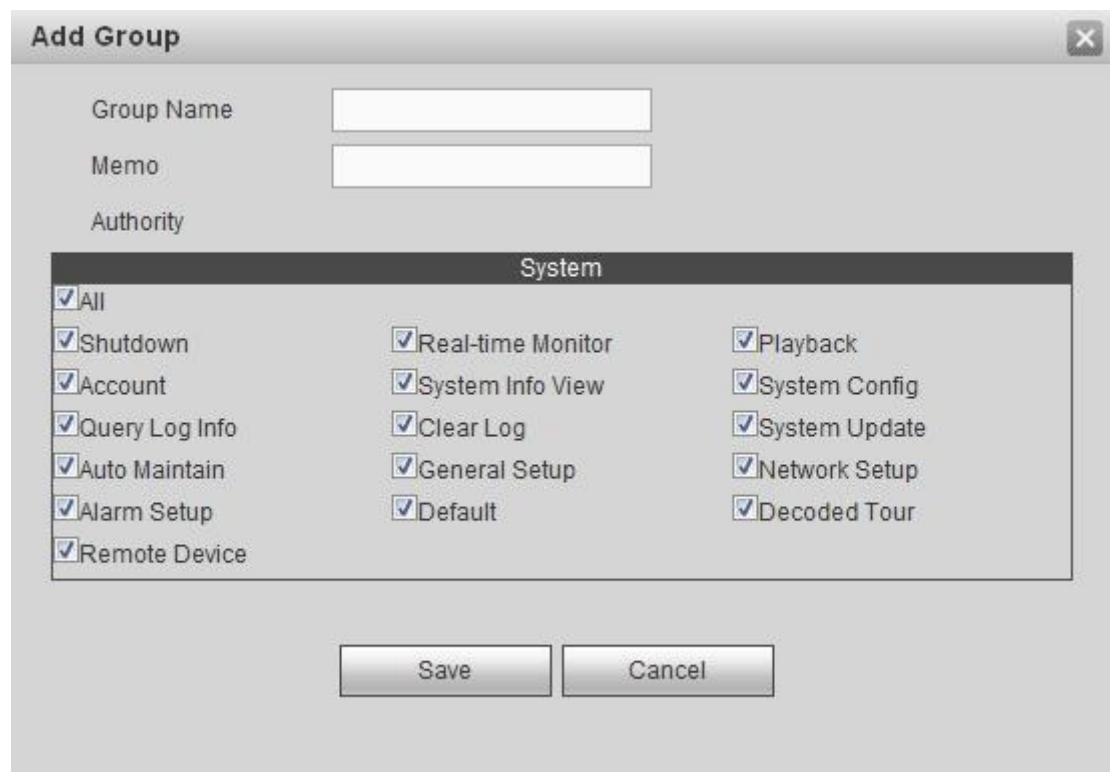

Figure 3-58

Modify Group

In Figure 3-57, click Modify button, you can see the following interface. Here you change group memory information, authorities and etc. See Figure 3-59.

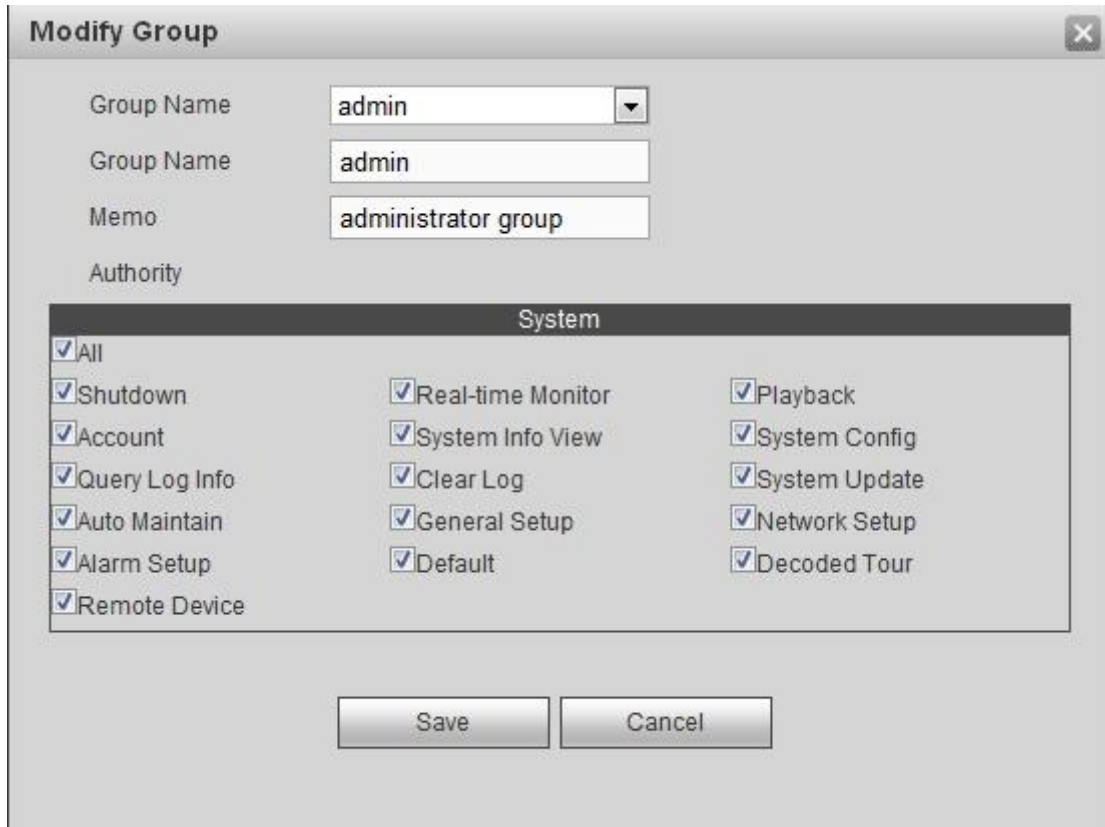

Figure 3-59

3.10 Maintain

3.10.1 Version

From Maintain->Version, here you can view device hardware feature and software version information. See Figure 3-60.

Version	
Alarm In:	16
Alarm Out:	8
SN:	YPA2KQ01700034
Web:	2.2.0.31
System Version:	3.200.0.0
Build Date:	2014-05-22

Figure 3-60

3.10.2 Log

From Maintain->log, here you can view system log. See Figure 3-61.

- Type: Log types include: system operation, configuration operation, alarm event, user management, log clear.
- Search: You can select log type from the drop down list and then click search button to view the list.
- Clear: You can click this button to delete all displayed log files.
- Backup: You can click this button to backup log files to current PC.

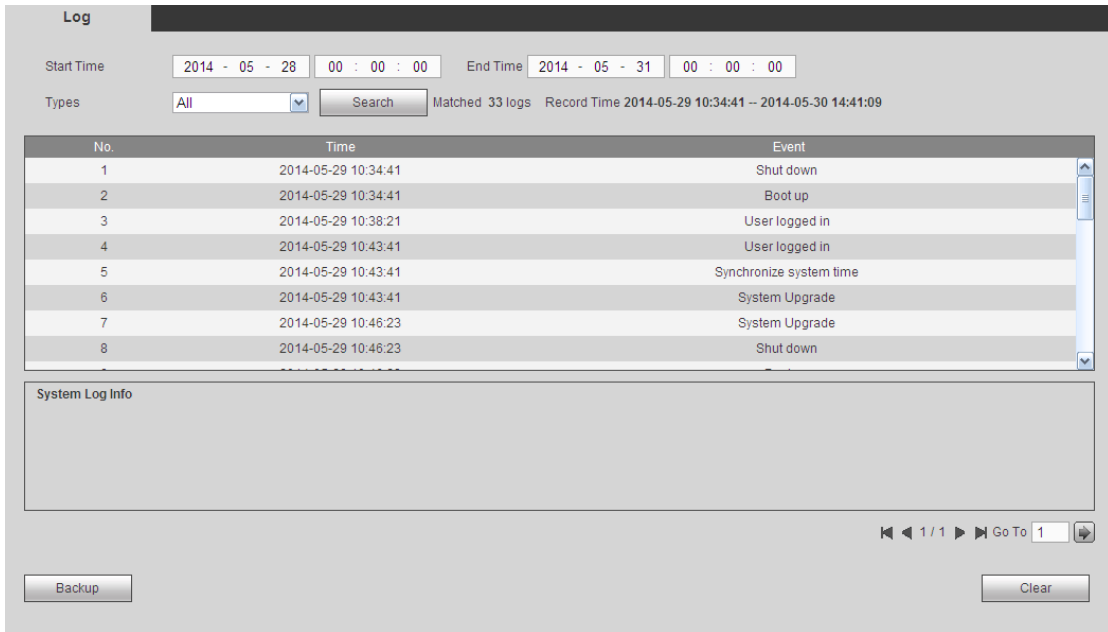

Figure 3-61

Click backup button, the interface is shown as in Figure 3-62.

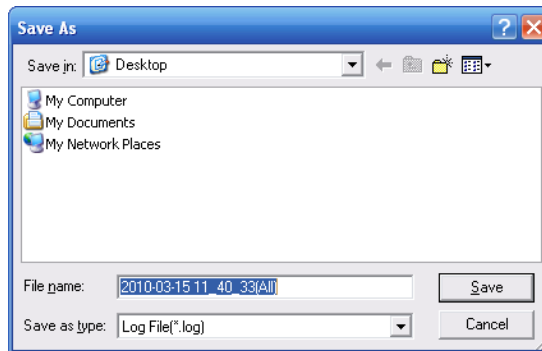

Figure 3-62

3.10.3 Sniffer

From Maintain->Sniffer, you can go to Sniffer interface. In this interface you can save Sniffer data to a flash drive.

Please follow the steps listed below.

- 1) Insert flash drive to the USB port at the front panel of the decoder and then click refresh button. After you see device name, space, you can see system has detected flash drive. Now you can go to the next step. See Figure 3-63.

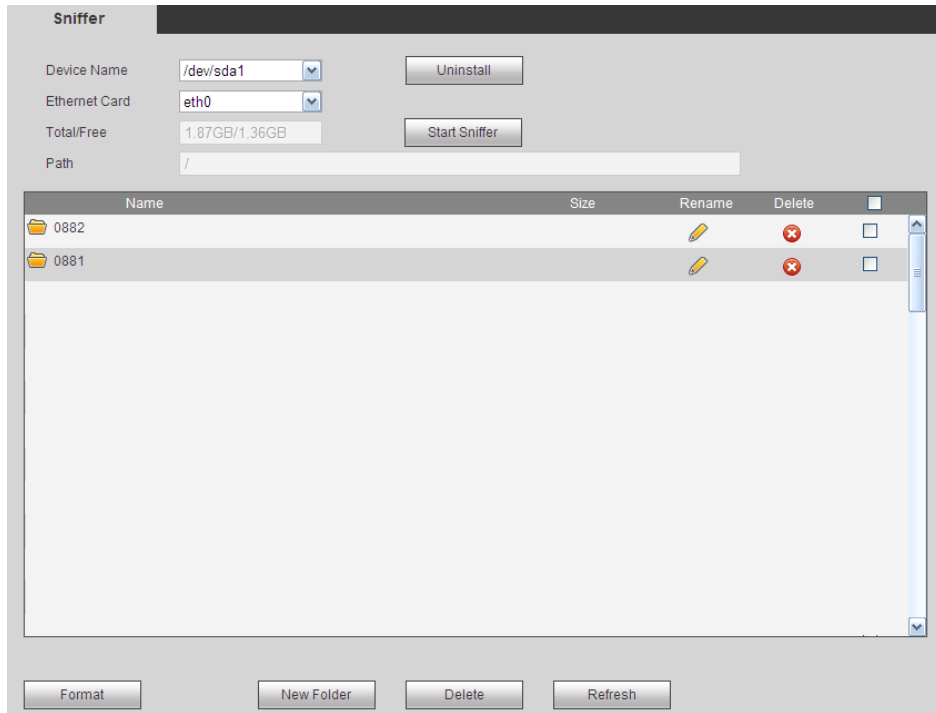

Figure 3-63

- 2) In Figure 3-63, click **Start Sniffer** button, you can see system writes data to the flash drive and the **Start Sniffer** button becomes **Stop Sniffer** button. See Figure 3-64.

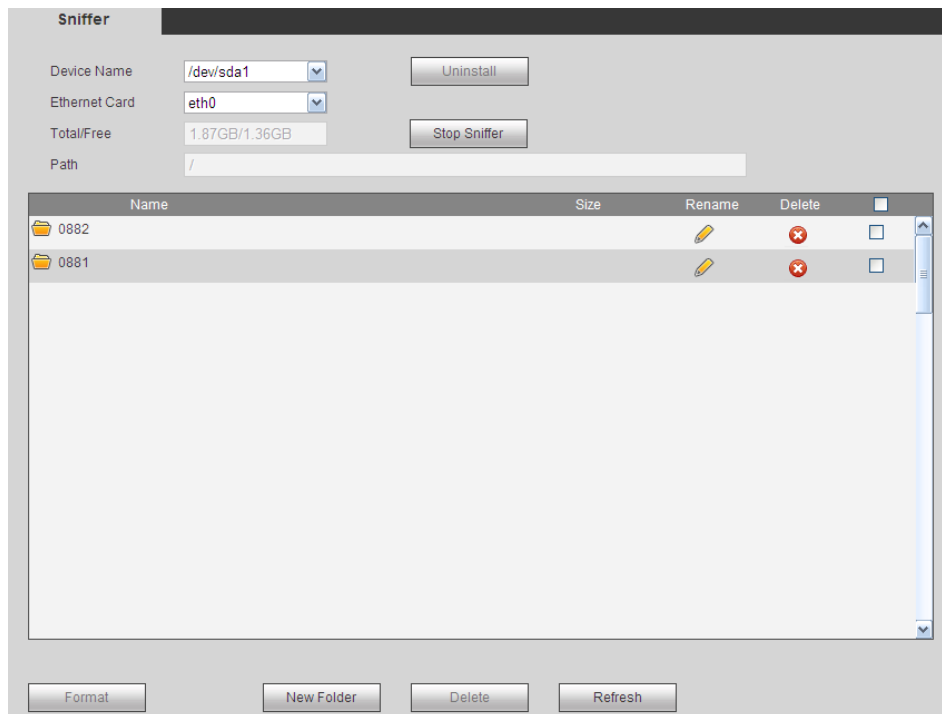

Figure 3-64

- 3) Click **Stop Sniffer** button, system stops writing data to the flash drive. Click refresh button, you can see a file with extension name. pcap. See Figure 3-65.

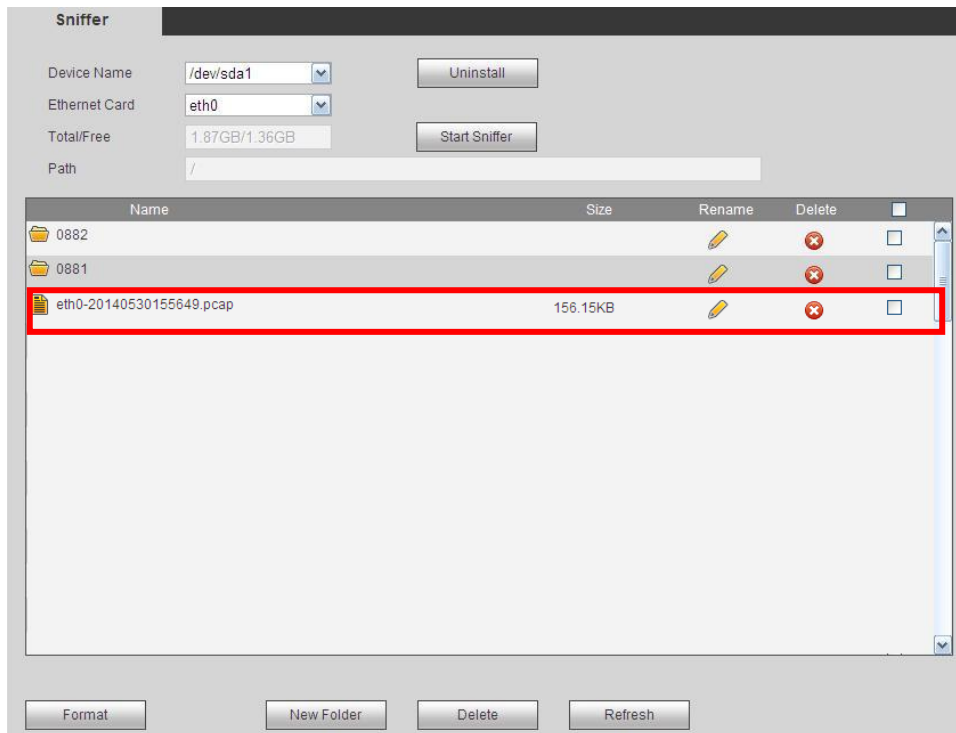

Figure 3-65

- 4) Click **Uninstall** button and remove the flash drive. See Figure 3-66.

Note

Before you remove flash drive, please click Uninstall button first.



Figure 3-66

- Begin Sniffer: Click it, system begins sniffer and write data to the specified directory of the flash drive.
- Stop Sniffer: Click it, system stops writing data to the flash drive.
- Uninstall: Click it and then remove the flash drive from the device.

Note

Before you remove flash drive, please click Uninstall button.

- Format: Click it to format current flash drive.

- Refresh: Click it to refresh flash drive Sniffer interface.
- Delete: Select a file from the flash drive and then click Delete button, you can delete it.

3.10.4 Default and Backup

Please note 16-channel high definition series does not support alarm default setup function.

From maintain->Default and backup, the default and backup interface is shown as below. See Figure 3-67.

- Select all: Check the box here to select general/RS232/Network/Alarm /decode tour/splicing wall/connection mode to restore factory default setup.
- Default: Restore factory default setup.
- Export: Export system configuration to local PC.
- Import: Import configuration from PC to the system.

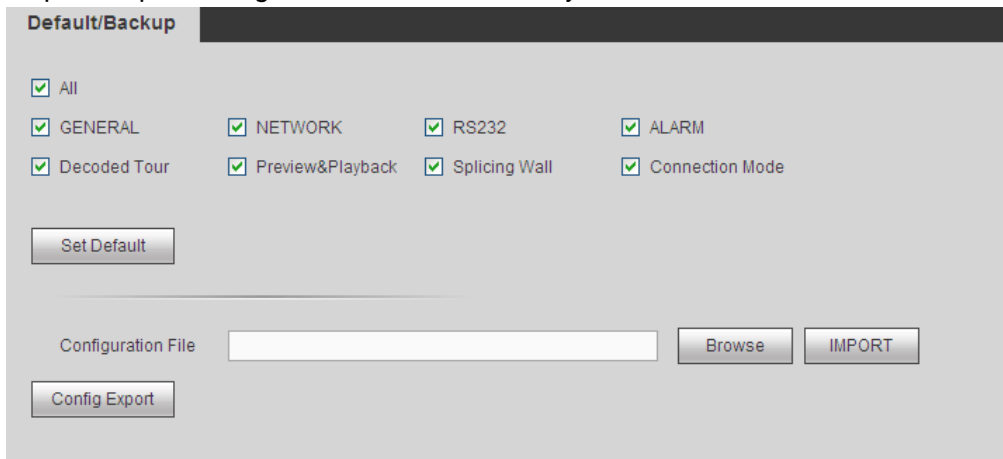

Figure 3-67

3.10.5 Auto Maintenance

From Maintain->auto maintenance, here you can select auto reboot and auto delete old files interval from the dropdown list. See Figure 3-68.

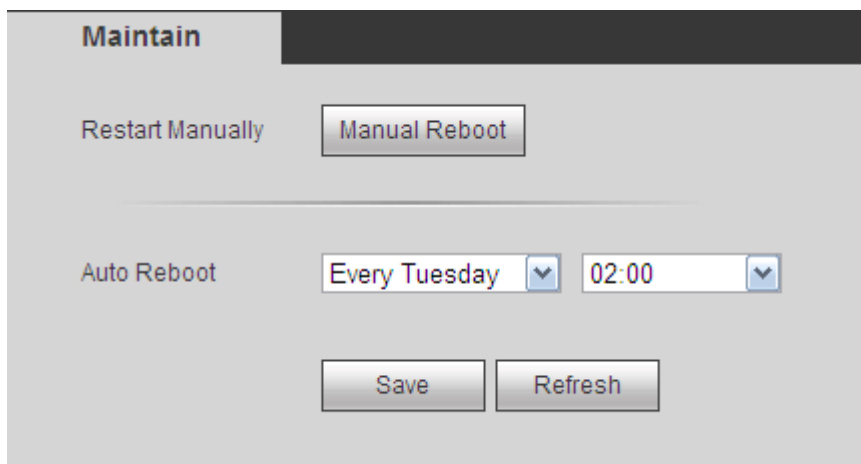

Figure 3-68

3.10.6 Connection mode

Important

Do not change the connection mode manually! After the decoder is added to the DSS2.2, it can auto switch to the transfer mode.

From Maintain->Connection mode, the connection mode interface is shown as below. See Figure 3-69.

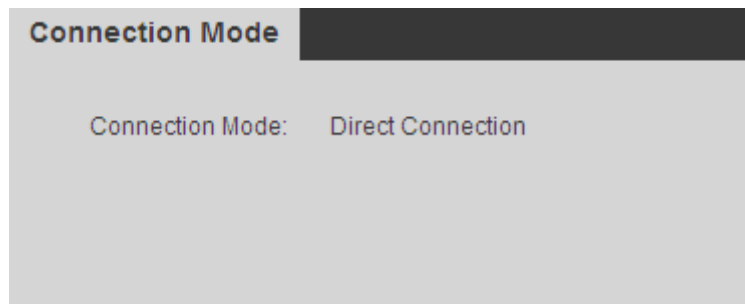

Figure 3-69

3.11 Log out

Click log out button, you can go back to login interface. See Figure 3-70.

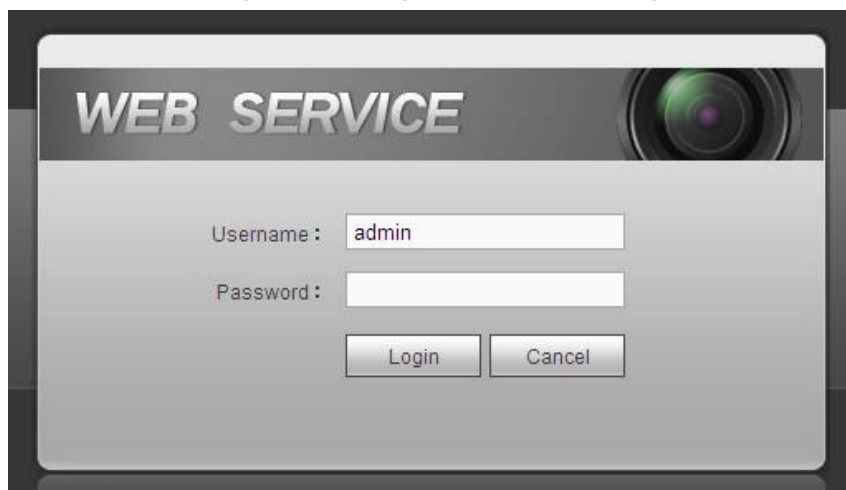

Figure 3-70

4 Local GUI Operation

This chapter is for 1-channel 4K high definition series product only.

4.1 Boot up



Caution

Before the boot up, please make sure:

- **For device security, please connect the HDMI-WALL to the power adapter first and then connect the device to the power socket.**
- **The rated input voltage matches the device power on-off button. Please make sure the power wire connection is OK. Then click the power on-off button.**
- **Always use the stable current, if necessary UPS is a best alternative measure.**

Please follow the steps listed below to boot up the device.

- Connect the device to the monitor and then connect a mouse.
- Connect power cable.
- Click the power button at the front or rear panel and then boot up the device. After device booted up, the system is in multiple-channel display mode by default.

4.2 About Interface

The main interface is shown as below. See Figure 4-1.

The local GUI interface consists of the three parts.

Please refer to the following sheet for detailed information.

SN	Name	Function
1	Main Interface	Right click mouse, you can see it includes the four items: MAIN MENU, REMOTE DEVICE, NETWORK, CLOSE.
2	Device Tree	It is to list current added device(s) and channel(s).
3	Shortcut Menu	It includes the 1/4/9/16 split mode and MAIN MENU shortcut button.

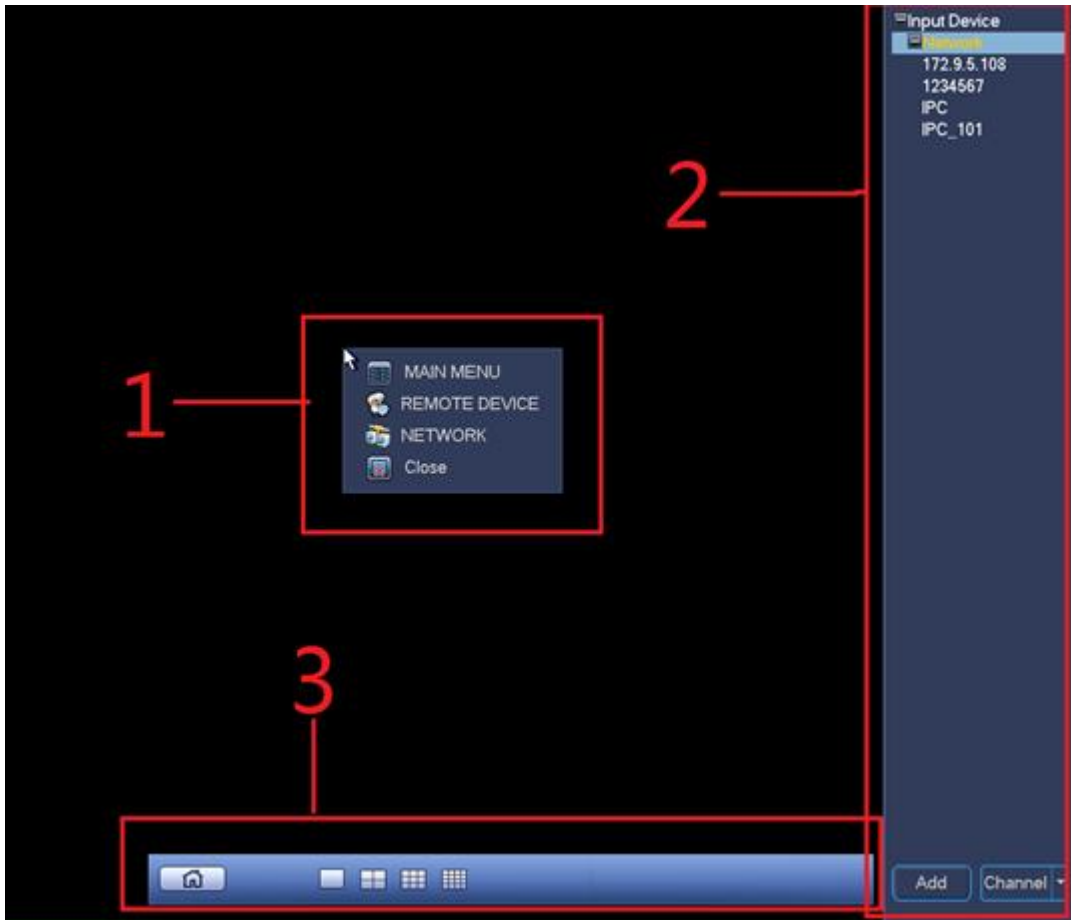

Figure 4-1

4.2.1 Main Interface

Right click mouse, you can see the menu includes four items: MAIN MENU (chapter 4.2.1), REMOTE DEVICE (chapter 4.3.1.3), NETWORK (chapter 4.3.1.2), CLOSE (chapter 4.3.4).

4.2.2 Device Tree

The device tree adopts the list to display current device and channel. The device tree function is disabled by default. Move you mouse to the right side margin of the screen, system can auto display the device tree. Right click the device tree to hide it.

4.2.2.1 Display Mode

At the right bottom corner, you can see there are two display modes: Device Display/Channel Display.

Select Device Display, you can see the following interface. See Figure 4-2.

Now you can see device name (pane 1) and the channels (pane 2).

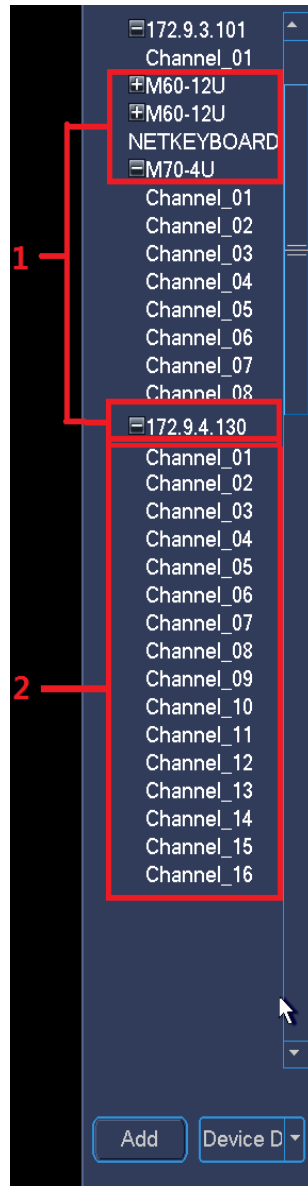

Figure 4-2

Select Channel Display, the device tree is shown as in Figure 4-3. In this mode, system does not display device, it only displays all channels.

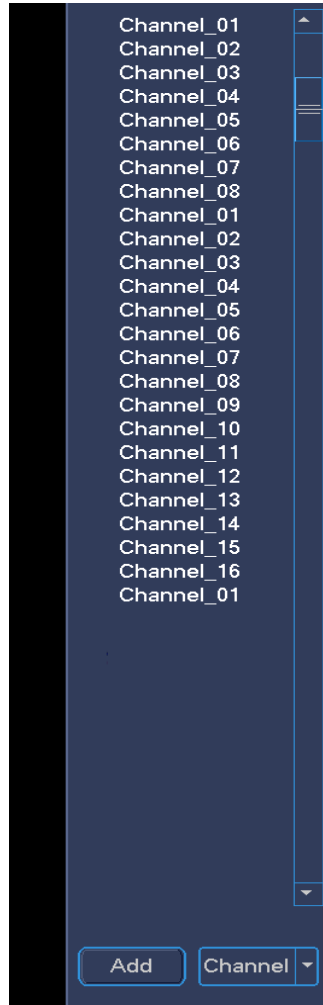

Figure 4-3

4.2.2.2 Shortcut Menu to Add Device

Click Add button, system pops up Remote Device interface. Please refer to chapter 4.3.1.3 for detailed information.

4.2.2.3 Output Current Channel to the TV Wall

There are two ways for you to output current channel to the TV wall.

- Drag the channel from the device tree to the corresponding window and then release.
- Select display window and then double click the channel.

4.2.3 Shortcut Menu

The shortcut menu consists of two items. It is hide by default. Move your mouse to the bottom of the display window, you can see it. Right click the shortcut menu, system auto hides it. See Figure 4-4.

- Pane 1: Click the button; you can go to the main menu.
- Pane 2: It is to display window split mode. It includes 1/4/9/16/25/36/64-window.

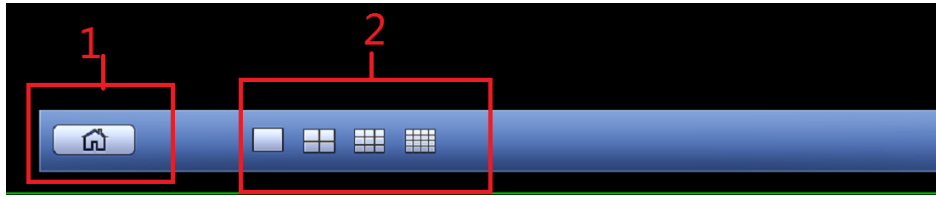

Figure 4-4

4.3 GUI Basic Operation

4.3.1 Main Menu

In Figure 4-1, click the button 1 to go to the following interface. See Figure 4-5. It includes seven items: General/network/remote device/decode info/sniffer/version/shutdown.



Figure 4-5

For General/network/remote device interface, you need to input corresponding user name and password to enter. See Figure 4-6.



Figure 4-6

4.3.1.1 General

General setting includes the following items. See Figure 4-7.

- System time: It is to change current system time and date. Please click Save button after the modification.
- Date format: There are three types: YYYY-MM-DD: MM-DD-YYYYY or DD-MM-YYYY.
- Date separator: There are three denotations to separate date: dot, beeline and solidus.
- Time format: It is to set time format: 24H/12H.
- Resolution: It is to set output resolution. The default setup is 1280*1024. **Please note system needs to reboot to activate current setup.**
- Output type: It is to set output type. It includes: VGA/HDMI.
- Device ID: Input a corresponding device name here.
- Device No: Here you can set device number.
- DST: Here you can set DST time and date. Here you can set start time and end time by setting corresponding week setup or by setting corresponding date setup. See Figure 4-8 and Figure 4-9.

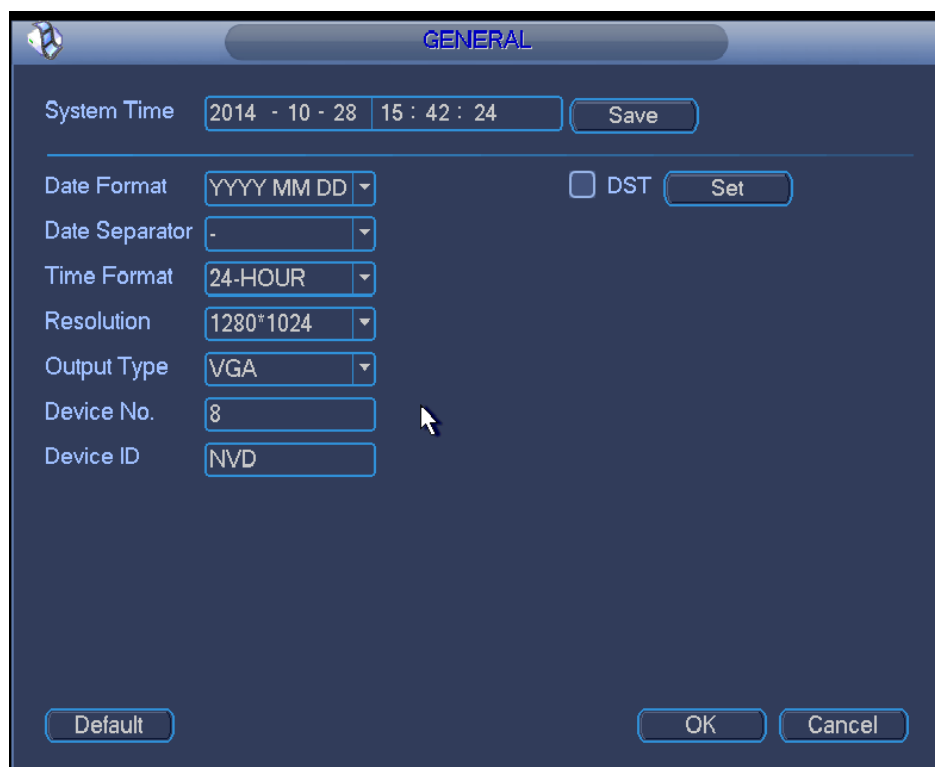

Figure 4-7



Figure 4-8



Figure 4-9

4.3.1.2 Network

The network interface is shown as in Figure 4-10.

- IP Version: There are two options: IPv4 and IPv6. Right now, system supports these two IP address format and you can access via them.
- MAC address: The host in the LAN can get a unique MAC address. It is for you to access in the LAN. It is read-only.
- IP address: Here you can use up/down button (▲▼) or input the corresponding number to input IP address. Then you can set the corresponding subnet mask the default gateway.
- Gateway: Here you can input the default gateway. Please note system needs to check the validity of all IPv6 addresses. The IP address and the default gateway shall be in the same IP section. That is to say, the specified length of the subnet prefix shall have the same string.
- DHCP: It is to auto search IP. When enable DHCP function, you can not modify IP/Subnet mask /Gateway. These values are from DHCP function. If you have not enabled DHCP function, IP/Subnet mask/Gateway display as zero. You need to disable DHCP function to view current IP information. Besides, when PPPoE is operating, you can not modify IP/Subnet mask /Gateway.
- TCP port: It is to set TCP port. Default value is 37777.
- UDP port: It is to set UDP port. Default value is 37778.
- HTTP port: It is to set HTTP port.
- HTTPS port: It is to set HTTPS port.

- Preferred DNS server: DNS server IP address.
- Alternate DNS server: DNS server alternate address.
- Default: It is to restore factory default setup.

The screenshot shows a 'NETWORK' configuration window with the following fields and values:

- IP Version: IPv4
- Mac Address: 14:08:21:14:22:03
- IP Address: 172 . 9 . 5 . 101
- Subnet Mask: 255 . 255 . 0 . 0
- Gateway: 172 . 9 . 0 . 1
- TCP Port: 37777
- UDP Port: 37778
- HTTP Port: 80
- HTTPS Port: 443
- Preferred DNS: 8 . 8 . 8 . 8
- Alternate DNS Server: 8 . 8 . 4 . 4

At the bottom of the window, there are three buttons: 'Default', 'Save', and 'Cancel'. The 'DHCP' checkbox is unchecked.

Figure 4-10

4.3.1.3 Remote Device

You can add network camera here. See Figure 4-11.

- IP search: It is to search the network devices in current IP segment.
- Add: It is to add selected device(s) to the list.
- Delete: It is to delete selected device(s).
- Manual add: It is to add one device manually.

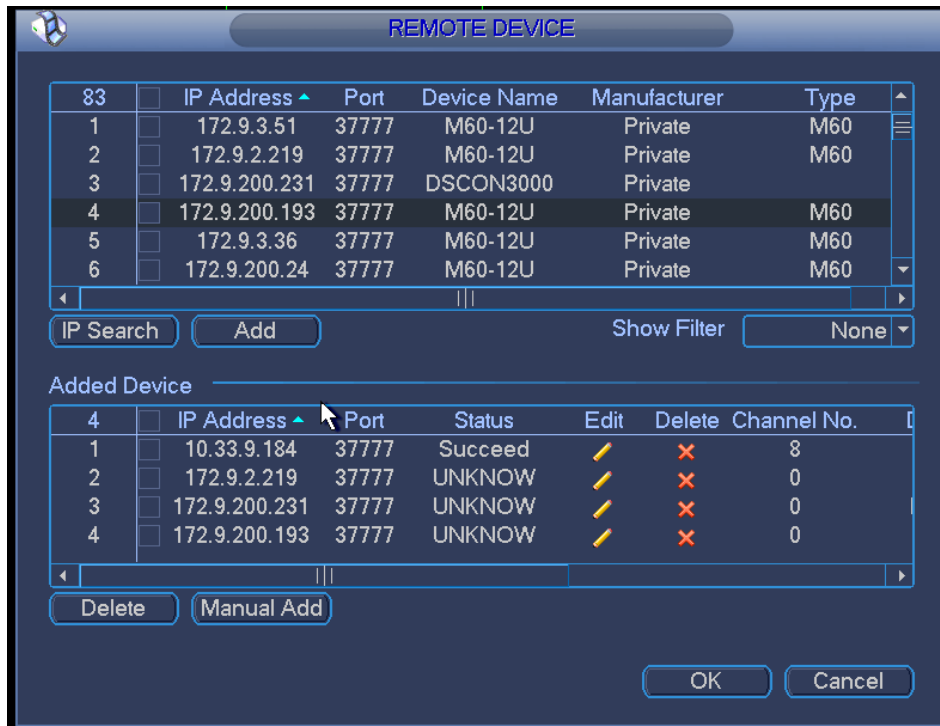

Figure 4-11

4.3.1.3.1 Add by IP Search

- 1) In Figure 4-11, Click IP search button, you can view all network devices in current IP segment. You can view device IP address, port, device name, manufacturer and type.
- 2) Check corresponding box to select the network device you want to add. You can select several devices one by one. Check the box at the top of the list, so that you can add all searched devices at the same time.
- 3) Click Add button, you can add the device to the list.
- 4) Click OK button.

4.3.1.3.2 Manual Add

- 1) In Figure 4-11, Click Manual add button.
- 2) System pops up the following interface. See Figure 4-12. Here you can input device name, manufacturer, IP address, TCP port, user, password.
- 3) Click OK button.

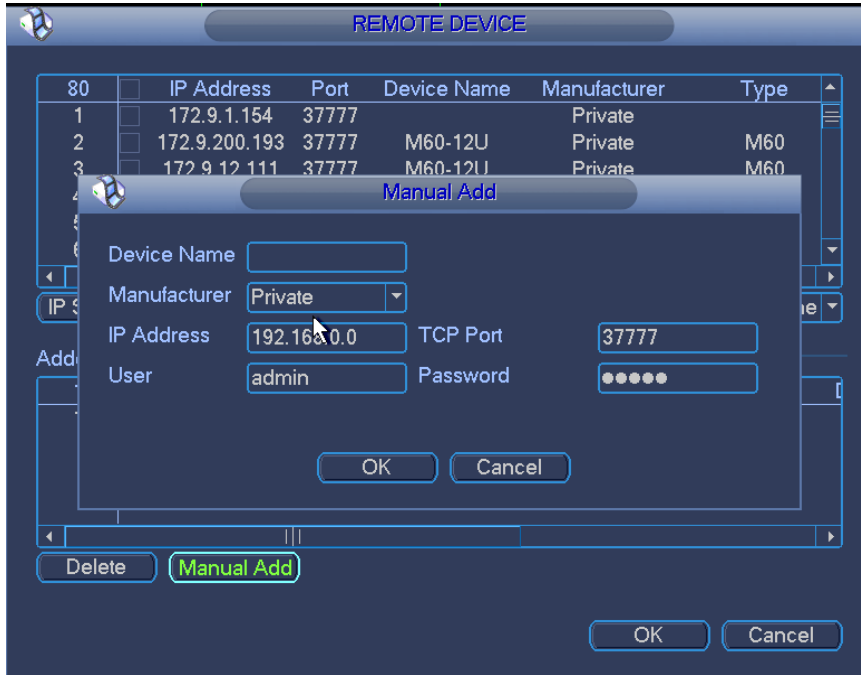

Figure 4-12

4.3.1.4 Decoded Info

It is display channel decoded information. See Figure 4-13.

- Resolution: Current bit stream resolution.
- Frame rate: Current bit stream frame rate.
- Data flow: Current bit stream connected data flow.
- Decoded flow: The decoded bit rate of current bit stream.

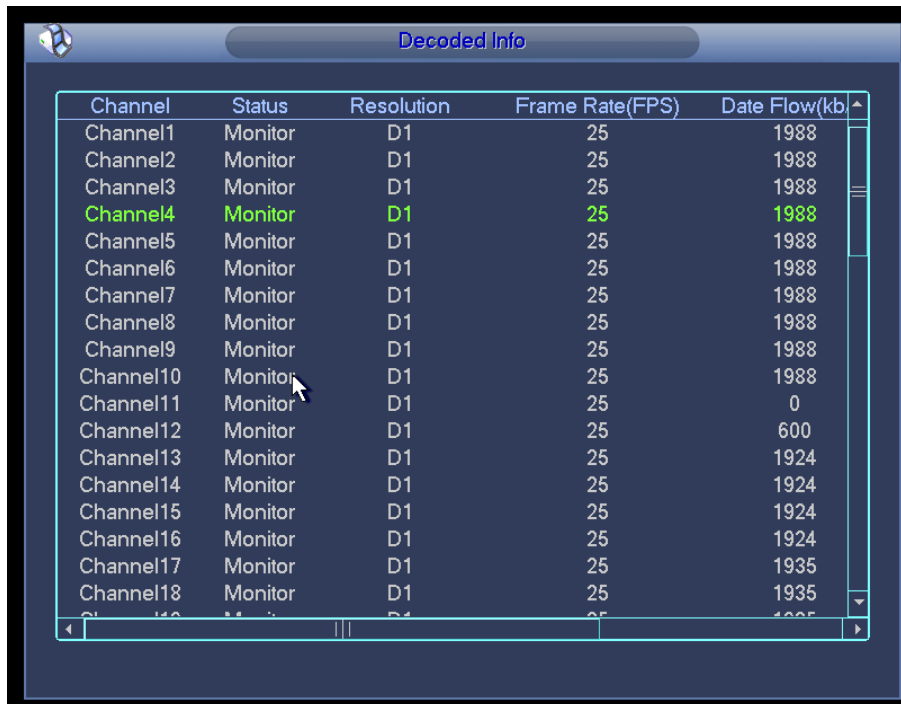

Figure 4-13

4.3.1.5 Sniffer

When there are some network problems such as you can not connect to the network device, or the video is not fluent, you can sniff the network data. You can sniff via the IP, port or protocol type. The sniffer data can be saved on the local of video general platform or the USB device of the video general platform. You can use the sniffer data to quickly find the reason.

Sniffer interface is shown as below. See Figure 4-14.

- Format: Click it to format current flash drive.
- Refresh: Click it to refresh flash drive Sniffer interface.
- Delete: Select a file from the flash drive and then click Delete button, you can delete it.
- New folder: It is to add a new folder and input customized folder name.

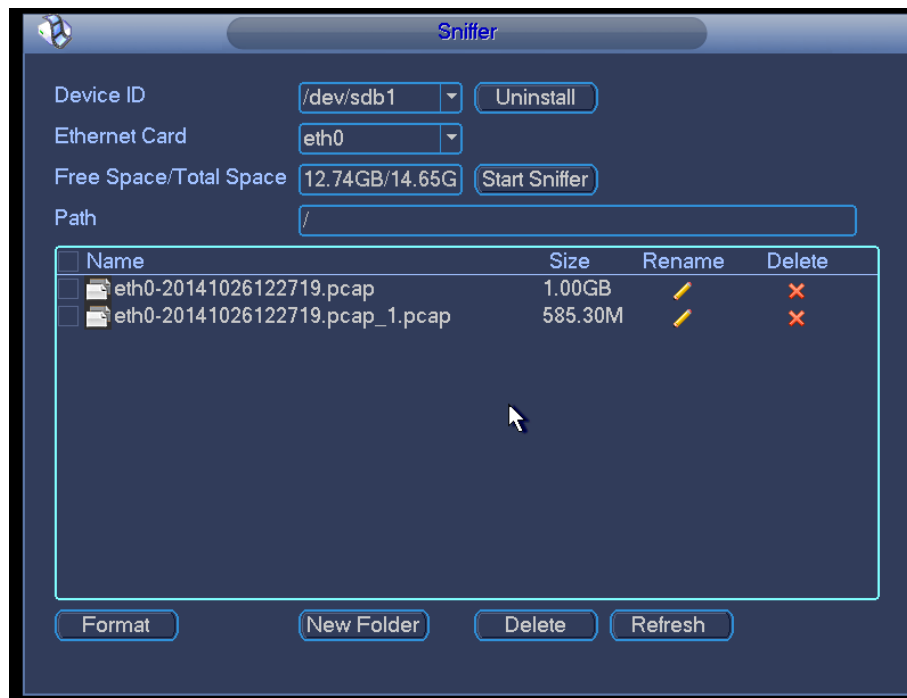

Figure 4-14

- 5) Insert flash drive to the USB port at the front panel of the decoder and then click refresh button. After you see device ID, free space, you can see system has detected flash drive. Now you can go to the next step. Otherwise, you need to check flash drive connection.
- 6) Select a folder (Click new folder button to add a new one and input customized name.)click **Start Sniffer** button, you can see system writes data to the flash drive and the **Start Sniffer** button becomes **Stop Sniffer** button.
- 7) Click Refresh button, you can see the sniffer file .pcap.
- 8) Click **Stop Sniffer** button, system stops writing data to the flash drive.

9) Click **Uninstall** button and remove the flash drive. See Figure 3-66.

Note

Before you remove flash drive, please click Uninstall button first.



Figure 4-15

4.3.1.6 Version

Double click Version button, you can view device current information or you can use the USB device to update the system. See Figure 4-16.

You can see alarm input channel, alarm output channel, system version, built date, Web version, SN and etc.

Before you update, please copy the upgrade file to your USB device and then insert the device to the USB port. Click the Start button to begin the upgrade process.



Figure 4-16

4.3.1.7 Shutdown

Double click shutdown button, system pops up a dialogue box for you to select. See Figure 4-17

- Logout menu user: log out menu. You need to input password when you login the next time.
- Shutdown: system shuts down and turns off power.
- Restart system: system begins rebooting.
- Switch user: you can use another account to log in.

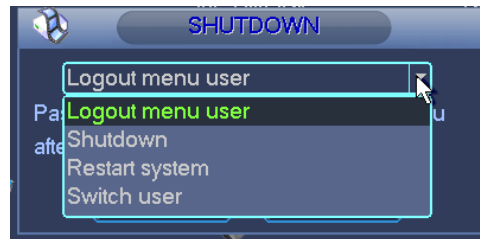

Figure 4-17

4.3.2 Remote Device

Please refer to chapter 4.3.1.3 for detailed information.

4.3.3 Network

Please refer to chapter 4.3.1.2 for detailed information.

4.3.4 Close

Click it, and then click OK button, system will close all windows.

Tips:

If you want to close one window, please move your mouse to the right corner of the displayed window and then you can see the  button. Click it, you can close one window.

5 Alarm Input and Output

Before device connection, please make sure:

- **Alarm Input**

Here we take NKB100 as an example.

Please check the alarm type (Normal open/normal close) first. Then set decoder network alarm type. Set decoder alarm type as NO (Normal Open) if it is ground alarm, otherwise set it as NC (Normal Close).

Please note alarm input is active in low voltage, please ground it.

Please use a relay to separate devices, when there are two decoders, or there is one decoder and one another device.

- **Alarm Output**

Do not connect the alarm output port to high power load directly (It shall be less than 1A); it may result in heavy current which may destroy the relay. Please use co contactor to realize the connection between the alarm output port and the load.

- **Sound Ground**

Please make sure the front-end device has earthed. Otherwise it may result in chip damage.

Alarm input type can be NO (normal open) or NC (normal close).

The 1-channel 4K high definition series product interface is shown as in Figure 5-1.

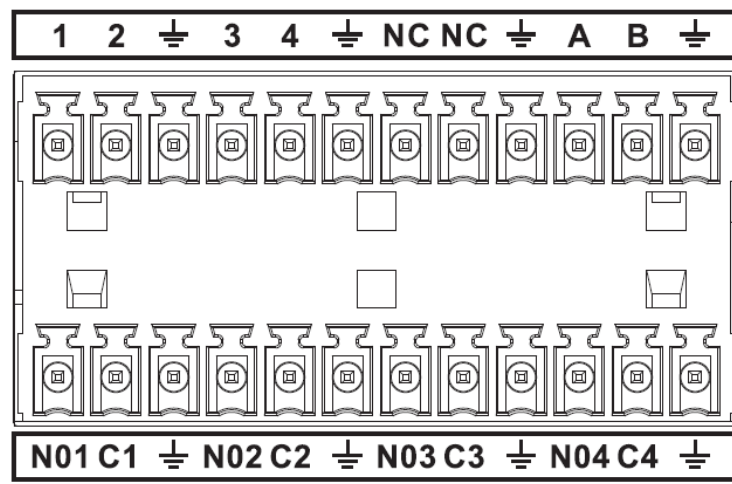

Figure 5-1

Parameter	1-channel 4K high definition series
AB	A/B cable of the control device.
GND	GND port
1~4	Alarm input port
C1-C4; N01-N04	Alarm output port (NO)

The 1/4-channel high definition series product interface is shown as in Figure 5-2.

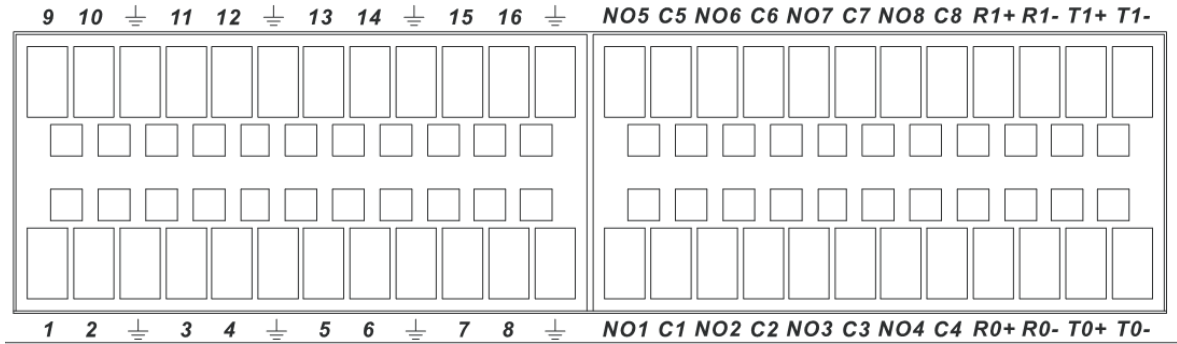

Figure 5-2

Parameter	1/4-channel high definition standard series, (Ground alarm)
\perp	GND port
1-16	Relay input port
C1-C8; NO1-NO8	Relay output port(NO)
R0+, R0-, R1+, R1-, T0+, T0-, T1+, T1-	Duplex RS485 port

The 9-channel high definition series product interface is shown as in Figure 5-3.

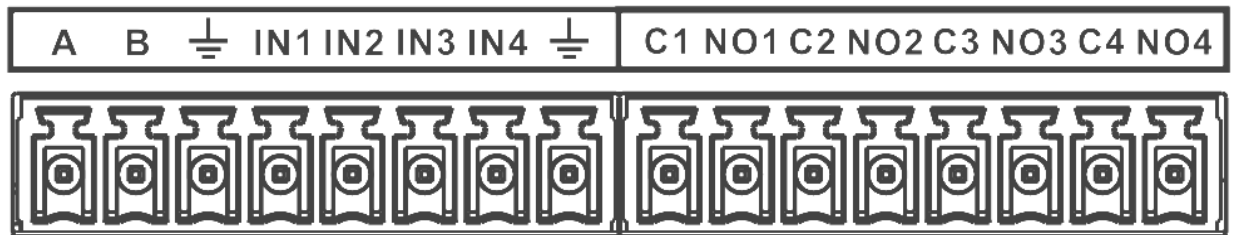

Figure 5-3

Parameter	9-channel high definition standard series
AB	A/B cable of the control device.
\perp	GND port
IN1-IN4	Alarm input port
C1-C4; NO1-NO4	Alarm output port (NO)

The 4-channel 4K high definition series product interface is shown as in Figure 5-4.

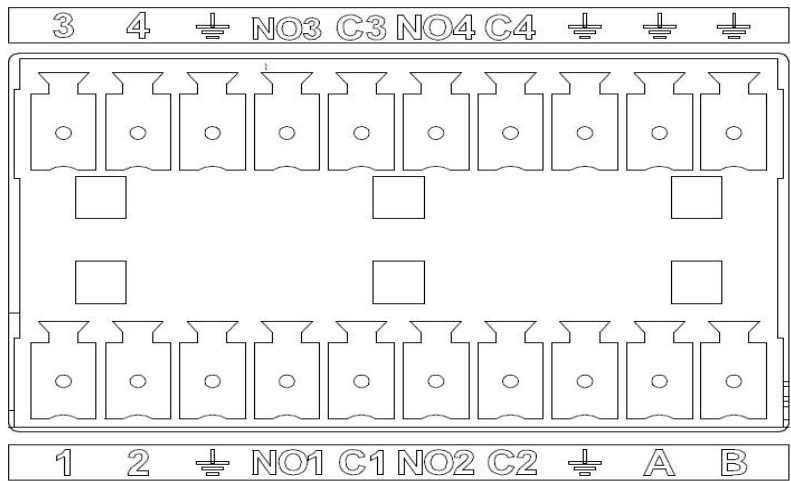

Figure 5-4

Parameter	4-channel 4K high definition series
AB	A/B cable of the control device.
⏏	GND port
IN1-IN4	Alarm input port
C1-C4; NO1-NO4	Alarm output port (NO)

5.1 Alarm Input Port

- There are 16-ch alarm inputs and the input type can be NO or NC.
- Connect the NC port of alarm detector to the HDMI-WALL alarm input port (ALARM)
- When using external power to provide power to the alarm device, please make it has the same ground with the HDMI-WALL.

Please refer to the following figure for more information. See Figure 5-5.

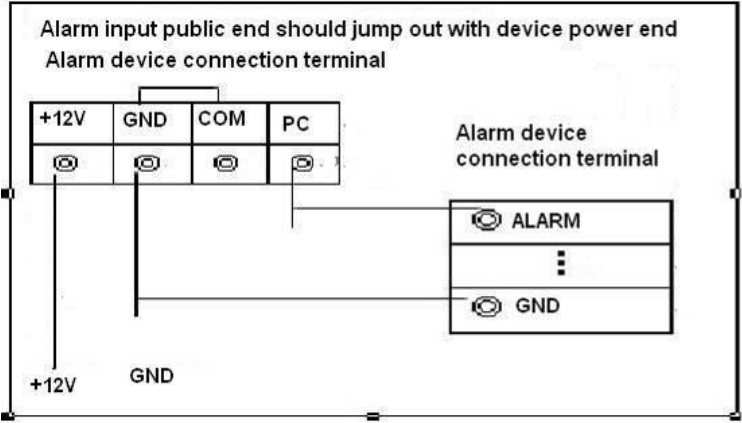

Figure 5-5

5.2 Alarm Output Port

- 8-ch alarm output (normal open contact). The external alarm device needs the battery supported.

- To avoid overload to damage the device, please refer to the following sheet for relay specification information.
- About A/B cable of RS485, they are used to connect to the PTZ decoder A/B cable. Please refer to Figure 5-6 for alarm input module information.

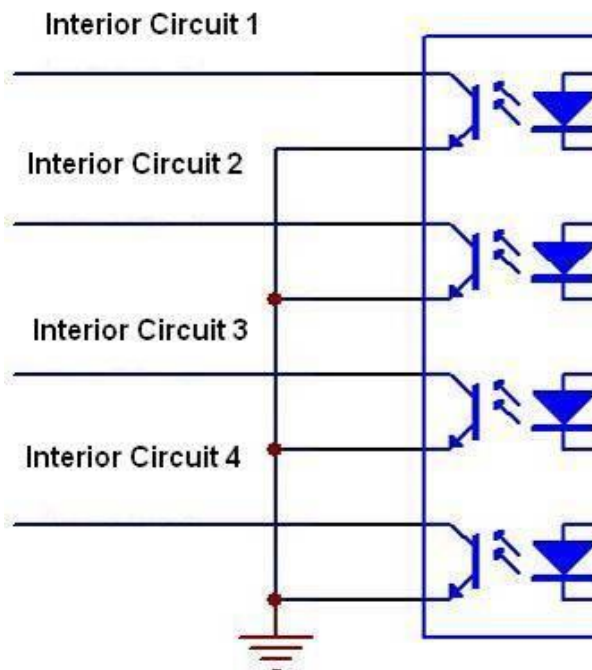

Figure 5-6

Please refer to Figure 5-7 for alarm output module information.

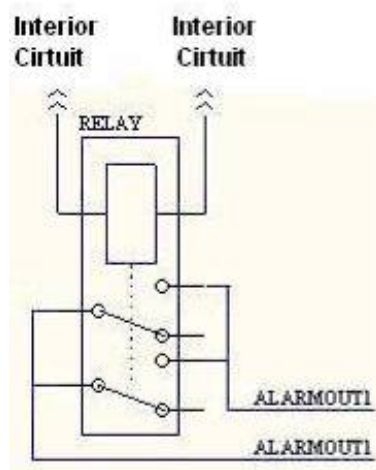

Figure 5-7

5.3 Alarm Output Relay Specifications

Contact Form	1Z
--------------	----

Contact Resistance	100mΩ (0.1A 6VDC)
Contact Material	AgNi+Gilded
Contact Rating (Resistive)	0.5A 125VAC/1A 30VDC
Max. switching voltage	125VAC/60VDC
Max. switching current	2A
Max. switching power	62.5VA/30W
Min. permissible loading	1mA 5V
Mechanical durability	1x10 ⁷ times (300 times/min)
Electrical durability	1x10 ⁵ times (30 times/min)

6 Network Keyboard Control Decoder Explanation

6.1 Connection

6.1.1 Keyboard Setup after Serial Ports Connected

The user must login decoder Web and choose “network keyboard “in serial port setup before connect the keyboard (such as IPJOYSTICK and the decoder. i.e.: system config.->RA232, then choose network keyboard in serial port function. Then set properties such as baud rate, data-bit, parity, stop-bit, and etc. (The default mode: baud rate: 9600; data bit: 8; stop bit: 1; parity: none). The properties of keyboard and DVR are required to be consistent.

Network keyboard config.: menu operation->control setup. (ID number, device name and connection type are also configured here)

- ID number

ID number is to recognize the front-end devices’ numbers

Configuration steps: move the cursor to ID number and input the number.

Note: if the device number is marked with”*”, e.g. if a user input “3”, then it will be shown as “*3”, which means that the front-end device that numbered 3 has finished control setup, user can thus read the type and name of NO.3 device.

ID Number:*3
Device Name:DVR-1
Device Type: DVR
Connection Type:RS232

- Device name

Name the front-end device. The keyboard supports multiple input methods.

- Device type

Choose DVR for the decoder. Types are DVR, Dome, CMS, and HDMI-WALL etc,. Choose front-end device type by controlling directional keys (left and right keys), then use directional keys (up and down) to set other configurations.

- Connection type

The connection type is determined by the connection way of keyboard and device.

e.g. the connection type is RS232 if the keyboard is connected to DVR via 232 interface.

232 address: 8	parity: N/A
protocal: DVR-2	stopbit: 1
baudrate:9600	
databit: 8	

- Setup steps

Use the directional key(up and down) to move the cursor to the connect type, and use directional keys(left and right) to choose the method. Press ENTER to go to the “config.” And set 232 address, protocol, baud rate, data bit, stop bit, parity and etc. there.

NOTE:

- RS232 address/485 address are the local numbers of the corresponding DVR.
- DVR-2 is used as general protocol. DVR-2 is a network keyboard protocol, which corresponds to the serial port protocol of a decoder.

6.1.2 Keyboard Setup after Network Connected

For NKB3000 series network keyboard, you need to set the network keyboard IP first, please refer to the following instructions.

Control IP: 192. 168. 090. 111
Control Port: 3777
Protocol: DVR--2

In the network keyboard, menu-> local config. -> Network config. Then set IP address, sub net mask, gateway and port. ID number, device name, and device type are needed to be set. (The same setup method as above)

The connection type is network connection. Use the directional keys(up and down) to move the cursor to the connection type and choose connection way by using directional keys(left and right), press ENTER to go to the “setup”, set control IP, control port and protocol. Then save.

Save data?
YES: ENTER, NO:ESC

After setup, press ESC to exit the control setup, at this time, a pop up will be shown, see figure press ENTER to save data and press ESC if you do not need the data anymore.

6.2 Login method

Users can choose any way to login: ID number, device name, IP address, 232 address, 485 address, then press ENTER to go to the setup and find the info that looking for, at last, press ENTER to finish the search.





If search is successful, it will auto connect, if the info. does not exist, it will be shown as follows: The address does not exist, please retry.

ID Number	485
Address	
Device Name	
IP Address	

Login by shortcut:

Look for the shortcut by ID: press ID button, enter ID number, and press ENTER. Press ENTER to go to the main menu after connected.

6.3 Picture switch

- Press  /  /  /  to switch window-mode: Single-split, 1/4/9/16 window split
- PREV: choose TV. 1-4: 4 TV NUMBERS
- Channel number: 1-16, 1-16 for each TV respectively

- Press number button to go to the designated channel, e.g. press 1# to go to the channel 1, but when one wants to go the channel 10(and above), one must use CAM button as well.
- e.g. CAM +channel #+CAM button. E.g. use the combination CAM+12+CAM to go to the channel 12.

The detailed operation steps:

- Press “PREV”+tv number+□, /田/■/■.
- Use a joystick or “→”←” to switch channels.

Note:

- **This manual for reference only. Slight difference may be found in the user interface.**
- **All the designs and software here are subject to change without prior written notice.**
- **All trademarks and registered trademarks mentioned are the properties of their respective owners.**
- **If there is any uncertainty or controversy, please refer to the final explanation of us.**
- **Please visit our website or contact your local retailer for more information.**